

Proximity sensors SIE..., inductive

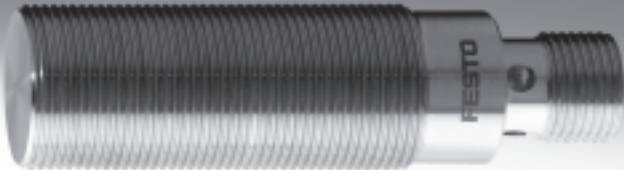

Proximity sensors SIE..., inductive

Product range overview

FESTO

Version	Type	Operating voltage	Switching output/ analogue output	Mounting type	Size	→ Page/ Internet
Reduction factor, material-specific						
Standard switching distance	SIEN Basic version	10 ... 30 V DC 15 ... 34 V DC	PNP NPN	Flush Non-flush	∅ 4 mm, M5, ∅ 6.5 mm, M8, M12, M18, M30	5
	SIEN-...-PA Polyamide housing	10 ... 30 V DC	PNP NPN	Flush Non-flush	M12, M18, M30	11
	SIED Basic version	20 ... 265 V AC 20 ... 320 V DC	Contactless, 2-wire	Flush Non-flush	M12, M18, M30	14
	SIED-...-PA Polyamide housing	20 ... 250 V AC 10 ... 300 V DC	Contactless, 2-wire	Flush Non-flush	M12, M18, M30	19
	SIES Special design	10 ... 30 V DC	PNP NPN	Flush	5x5x25 mm ... 40x40x120 mm	22
Increased switching distance	SIEH Basic version	10 ... 30 V DC 15 ... 34 V DC	PNP NPN	Flush	∅ 3 mm, M12, M18	26
	SIEH-...-CR Stainless steel housing	10 ... 30 V DC	PNP NPN	Flush	M12, M18	30
Analogue output	SIEA	15 ... 30 V DC	0 ... 10 V and 4 ... 20 mA	Flush	M8, M12, M18, M30	33
Reduction factor 1 for all metals, welding field immune						
Increased switching distance	SIEF Basic version	10 ... 65 V DC	PNP NPN	Flush Partially flush	M8, M12, M18, M30 40x40x65 mm	36
	SIEF-...-WA Housing resistant to welding spatter	10 ... 30 V DC	PNP NPN	Flush Partially flush	M12, M18, M30	42

Proximity sensors SIE..., inductive

Peripherals overview

SIE...

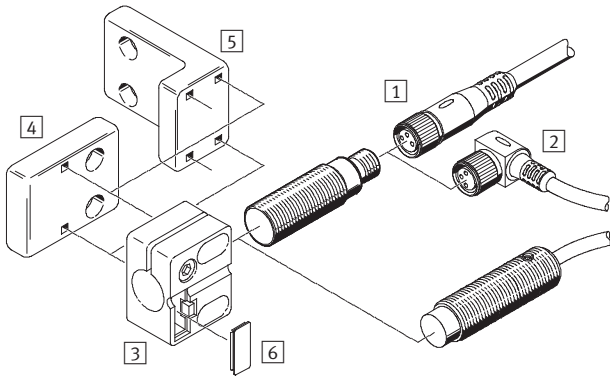

SIES-V3B

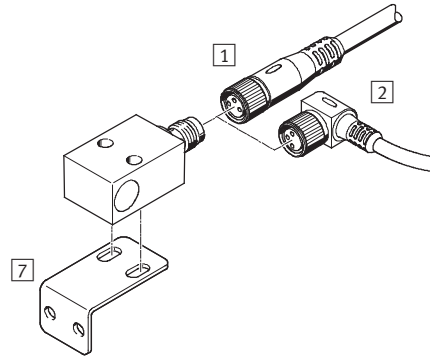

Mounting attachments and accessories		→ Page/ Internet
1	Connecting cable, straight socket NEBU-M...G...	46
2	Connecting cable, angled socket NEBU-M...W...	46
3	Sensor bracket SIEZ-...B	46
4	Sensor bracket SIEZ-UV	46
5	Sensor bracket SIEZ-UH	46
6	Inscription label SIEZ-LB	46
7	Mounting bracket HV-M5	46

Mounting attachments and accessories		→ Page/ Internet
-	Foot mounting HBN	46
-	Foot mounting HBE	46
-	Flange mounting FBN	46
-	Stop for proximity SDA	46

Proximity sensors SIE..., inductive

Type codes

		SIE	N	-	M	30	NB	-	P	S	-	K	-	L	-	
Type																
SIE	Proximity sensor, inductive															
Type																
A	With analogue output															
D	For DC and AC voltage															
F	With reduction factor 1 for all metals, welding field immune															
H	With increased switching distance															
N	With standard switching distance															
S	Special design															
Design																
-	Round															
M	Metric thread															
Q	Block-shaped															
V3	Block-shaped															
Size																
Mounting type																
B	Flush															
NB	Non-flush															
S	Partially flush															
Electrical output																
P	Switching output PNP															
N	Switching output NPN															
Z	2-wire output															
PU	Analogue output 0 ... 10 V															
UI	Analogue output 0 ... 10 V and 4 ... 20 mA															
Switching element function																
S	N/O contact															
O	N/C contact															
A	Antivalent															
Electrical connection																
K	Cable															
S	Plug															
X	Screw terminals															
Display																
-	Without display															
L	Switching status															
2L	Switching status and ready status															
Version																
-	Standard															
CR	Stainless steel housing															
PA	Polyamide housing															
WA	Housing resistant to welding spatter															

Proximity sensors SIEN, inductive

Technical data – Standard switching distance, basic version

Function¹⁾

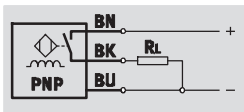

- Standard switching distance
- For DC voltage
- Round design

1) e.g. N/O contact with PNP output and cable

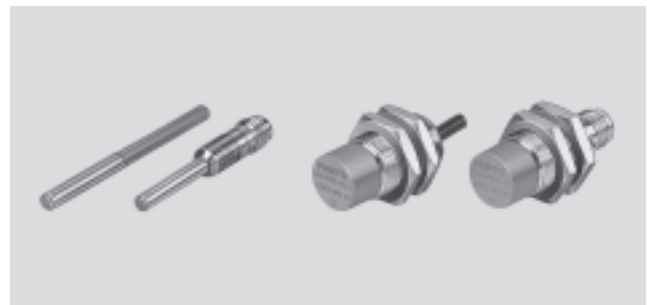

General technical data							
Size	4 mm	M5	6.5 mm	M8	M12	M18	M30
Conforms to	EN 60947-5-2						
Certification	cULus listed (OL) RCM trademark						
CE mark (see declaration of conformity)	To EU EMC Directive ¹⁾						
Note on materials	Free of copper and PTFE RoHS-compliant – Contains PWIS (paint-wetting impairment substances)						

1) For information about the applicability of the component see the manufacturer's EC declaration of conformity at: www.festo.com → Support → User documentation.
If the component is subject to restrictions on usage in residential, office or commercial environments or small businesses, further measures to reduce the emitted interference may be necessary.

Input signal/measuring element							
Size	4 mm	M5	6.5 mm	M8	M12	M18	M30
Ambient temperature	[°C]	–25 ... +70					

Output, general												
Mounting type	Flush							Non-flush				
Size	4 mm	M5	6.5 mm	M8	M12	M18	M30	M8	M12	M18	M30	
Repetition accuracy	[mm]	0.04	0.04	0.07	0.07	0.1	0.25	0.5	0.12	0.2	0.4	0.75

Switching output												
Mounting type	Flush							Non-flush				
Size	4 mm	M5	6.5 mm	M8	M12	M18	M30	M8	M12	M18	M30	
Switching output	PNP							PNP				
	NPN							NPN				
Switching element function	N/O contact							N/O contact				
	N/C contact							N/C contact				
Rated operating distance	[mm]	0.8	0.8	1.5	1.5	2	5	10	2.5	4	8	15
Assured switching distance	[mm]	0.64	0.64	1.21	1.21	1.62	4.05	8.1	2.03	3.24	6.48	12.15

Reduction factors												
Aluminium	0.4	0.4	0.25	0.25	0.4	0.4	0.45	0.25	0.5	0.5	0.5	
Stainless steel St 18/8	0.7	0.7	0.7	0.7	0.6	0.8	0.8	0.7	0.9	0.8	0.85	
Copper	0.3	0.3	0.2	0.2	0.3	0.4	0.4	0.2	0.5	0.4	0.43	
Brass	0.4	0.4	0.35	0.35	0.5	0.5	0.55	0.35	0.6	0.5	0.53	
Steel St 37	1.0	1.0	1.0	1.0	1.0	1.0	1.0	1.0	1.0	1.0	1.0	
Hysteresis	[mm]	–	–	≤ 0.07	≤ 0.07	≤ 0.18	≤ 0.55	≤ 1.1	≤ 0.12	≤ 0.36	≤ 0.88	≤ 1.65
Max. switching frequency	[Hz]	3,000	3,000	5,000	5,000	3,000	2,000	1,200	3,000	2,000	2,000	700
Max. output current	[mA]	200										
Voltage drop	[V]	0 ... 2										

Proximity sensors SIEN, inductive

Technical data – Standard switching distance, basic version

FESTO

Output, additional data							
Size	4 mm	M5	6.5 mm	M8	M12	M18	M30
Protection against short circuit	Pulsed						
Inductive protective circuit	Integrated						
Induced voltage protection	Integrated		–				

Electronic components							
Size	4 mm	M5	6.5 mm	M8	M12	M18	M30
Operating voltage range [V DC]	10 ... 30						
Residual ripple [%]	10			±10		±20	
Idle current [mA]	0 ... 10						
Reverse polarity protection	For all electrical connections						

Electromechanical components							
Size	4 mm	M5	6.5 mm	M8	M12	M18	M30
Cable							
Electrical connection	Cable, 3-wire						
Cable length [m]	2.5						
Cable sheath material	TPE-U (PUR)						
Plug							
Electrical connection	Plug, M8x1, 3-pin	Plug, M8x1, 3-pin	Plug, M8x1, 3-pin	Plug, M8x1, 3-pin	Plug, M12x1, 3-pin	Plug, M12x1, 3-pin	Plug, M12x1, 3-pin

Mechanical components											
Size	4 mm	M5	6.5 mm	M8	M12	M18	M30				
Attachment type	Clamped	Via lock nut	Clamped	Via lock nut							
Mounting type	Flush			Flush	Non-flush	Flush	Non-flush	Flush	Non-flush	Flush	Non-flush
Tightening torque [Nm]	–	2	–	–	–	20	–	–	–	40	–
Cable											
Product weight [g]	48	48	45	53	53	110	90	108	105	155	150
Housing material	High-alloy stainless steel					Nickel-plated brass				Chrome-plated brass	
	–	PA	–	–							
	–	–	PBTP								
Plug											
Product weight [g]	9	9	4	18	18	30	25	43	40	100	100
Housing material	High-alloy stainless steel					–					
	–	–	Chrome-plated brass			Nickel-plated brass				Chrome-plated brass	
	–	PA	–								
	–	–	PBTP								

Display/operation	
Switching status display	Yellow LED

Proximity sensors SIEN, inductive

Technical data – Standard switching distance, basic version

Immissions/emissions							
Size	4 mm	M5	6.5 mm	M8	M12	M18	M30
Ambient temperature with flexible cable installation [°C]	–	–5 ... +70	–5 ... +70			–5 ... +70	
Protection class	–		IP65			–	
	IP67		IP67			IP67	
Surge strength [kV]	–	1	–			0.8	
Corrosion resistance class CRC ¹⁾	–	4	2			–	
Degree of contamination	–	3	–			3	

- 1) Corrosion resistance class 2 according to Festo standard 940 070
 Components subject to moderate corrosion stress. Externally visible parts with primarily decorative surface requirements which are in direct contact with a normal industrial environment or media such as coolants or lubricating agents.
 Corrosion resistance class 4 according to Festo standard 940 070
 Components with very heavy corrosion exposure. Components in contact with aggressive media, e.g. in food or chemical industries. These applications must, if necessary, be verified by special tests with the media concerned.

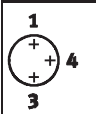
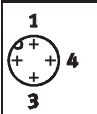
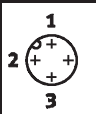
Pin allocation to EN 60947-5-2											
M8x1, 3-pin				M12x1, 3-pin				N/C contact			
N/O contact and N/C contact				N/O contact				N/C contact			
	Pin	Wire colour	Allocation		Pin	Wire colour	Allocation		Pin	Wire colour	Allocation
	1	Brown	+		1	Brown	+		1	Brown	+
	3	Blue	–		3	Blue	–		3	Blue	–
	4	Black	Output		4	Black	Output		2	White	Output

Dimensions – 4 mm Download CAD data → www.festo.com

Flush fitting
Cable

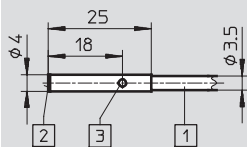

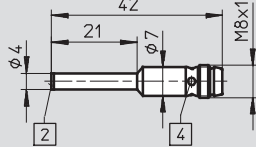

- 1 Connecting cable
- 2 Active surface
- 3 LED
- 4 4x LED

Dimensions – M5 Download CAD data → www.festo.com

Flush fitting
Cable

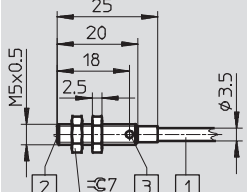

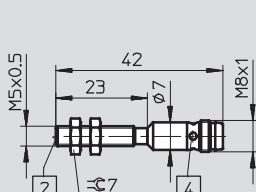

- 1 Connecting cable
- 2 Active surface
- 3 LED
- 4 4x LED

Dimensions – 6.5 mm Download CAD data → www.festo.com

Flush fitting
Cable

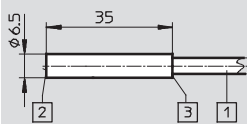

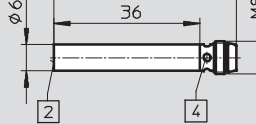

- 1 Connecting cable
- 2 Active surface
- 3 LED
- 4 4x LED

Proximity sensors SIEN, inductive

Technical data – Standard switching distance, basic version



Dimensions – M8 Download CAD data → www.festo.com

Flush fitting Cable	Plug	Non-flush fitting Cable	Plug
1 Connecting cable	2 Active surface	3 LED	4 4x LED

Dimensions – M12 Download CAD data → www.festo.com

Flush fitting Cable	Plug	Non-flush fitting Cable	Plug
1 Connecting cable	2 Active surface	3 LED	4 4x LED

Dimensions – M18 Download CAD data → www.festo.com

Flush fitting Cable	Plug	Non-flush fitting Cable	Plug
1 Connecting cable	2 Active surface	3 LED	4 4x LED

Dimensions – M30 Download CAD data → www.festo.com

Flush fitting Cable	Plug	Non-flush fitting Cable	Plug
1 Connecting cable	2 Active surface	3 LED	4 4x LED

Proximity sensors SIEN, inductive

Technical data – Standard switching distance, basic version

Fitting instructions

Flush fitting

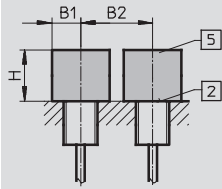

- 2 Active surface
- 5 Metal-free zone

Non-flush fitting

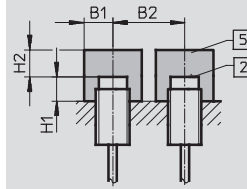

- 2 Active surface
- 5 Metal-free zone

Size	B1	B2	H
4 mm	2.5	5	2
M5	3.3	5	2.4
6.5 mm	5	9.5	4.5
M8	5.5	10	4.5
M12	8	18	6
M18	14	32	15
M30	25	60	30

Size	B1	B2	H1	H2
M8	9	16	8	7.5
M12	12	28	6	12
M18	20	50	10	24
M30	30	75	15	45

Ordering data







Size	S _n ¹⁾ [mm]	Mounting type	Switching output	Switching element function	Electrical connection			
					Cable		Plug	
					Part No.	Type	Part No.	Type
4 mm								
	0.8	Flush	PNP	N/O contact	150362	SIEN-4B-PS-K-L	150363	SIEN-4B-PS-S-L
				N/C contact	150366	SIEN-4B-PO-K-L	150367	SIEN-4B-PO-S-L
			NPN	N/O contact	150360	SIEN-4B-NS-K-L	150361	SIEN-4B-NS-S-L
				N/C contact	150364	SIEN-4B-NO-K-L	150365	SIEN-4B-NO-S-L
M5								
	0.8	Flush	PNP	N/O contact	150370	SIEN-M5B-PS-K-L	150371	SIEN-M5B-PS-S-L
				N/C contact	150374	SIEN-M5B-PO-K-L	150375	SIEN-M5B-PO-S-L
			NPN	N/O contact	150368	SIEN-M5B-NS-K-L	150369	SIEN-M5B-NS-S-L
				N/C contact	150372	SIEN-M5B-NO-K-L	150373	SIEN-M5B-NO-S-L
6.5 mm								
	1.5	Flush	PNP	N/O contact	150378	SIEN-6,5B-PS-K-L	150379	SIEN-6,5B-PS-S-L
				N/C contact	150382	SIEN-6,5B-PO-K-L	150383	SIEN-6,5B-PO-S-L
			NPN	N/O contact	150376	SIEN-6,5B-NS-K-L	150377	SIEN-6,5B-NS-S-L
				N/C contact	150380	SIEN-6,5B-NO-K-L	150381	SIEN-6,5B-NO-S-L
M8								
	1.5	Flush	PNP	N/O contact	150386	SIEN-M8B-PS-K-L	150387	SIEN-M8B-PS-S-L
				N/C contact	150390	SIEN-M8B-PO-K-L	150391	SIEN-M8B-PO-S-L
			NPN	N/O contact	150384	SIEN-M8B-NS-K-L	150385	SIEN-M8B-NS-S-L
				N/C contact	150388	SIEN-M8B-NO-K-L	150389	SIEN-M8B-NO-S-L
	2.5	Non-flush	PNP	N/O contact	150394	SIEN-M8NB-PS-K-L	150395	SIEN-M8NB-PS-S-L
				N/C contact	150398	SIEN-M8NB-PO-K-L	150399	SIEN-M8NB-PO-S-L
			NPN	N/O contact	150392	SIEN-M8NB-NS-K-L	150393	SIEN-M8NB-NS-S-L
				N/C contact	150396	SIEN-M8NB-NO-K-L	150397	SIEN-M8NB-NO-S-L

1) S_n Rated operating distance [mm]

Proximity sensors SIEN, inductive

FESTO

Technical data – Standard switching distance, basic version

Ordering data									
Size	S _n ¹⁾ [mm]	Mounting type	Switching output	Switching element function	Electrical connection				
					Cable			Plug	
					Part No.	Type	Part No.	Type	
M12									
	2.0	Flush	PNP	N/O contact	150402	SIEN-M12B-PS-K-L	150403	SIEN-M12B-PS-S-L	
				N/C contact	150406	SIEN-M12B-PO-K-L	150407	SIEN-M12B-PO-S-L	
			NPN	N/O contact	150400	SIEN-M12B-NS-K-L	150401	SIEN-M12B-NS-S-L	
				N/C contact	150404	SIEN-M12B-NO-K-L	150405	SIEN-M12B-NO-S-L	
	4.0	Non-flush	PNP	N/O contact	150410	SIEN-M12NB-PS-K-L	150411	SIEN-M12NB-PS-S-L	
				N/C contact	150414	SIEN-M12NB-PO-K-L	150415	SIEN-M12NB-PO-S-L	
			NPN	N/O contact	150408	SIEN-M12NB-NS-K-L	150409	SIEN-M12NB-NS-S-L	
				N/C contact	150412	SIEN-M12NB-NO-K-L	150413	SIEN-M12NB-NO-S-L	
M18									
	5.0	Flush	PNP	N/O contact	150418	SIEN-M18B-PS-K-L	150419	SIEN-M18B-PS-S-L	
				N/C contact	150422	SIEN-M18B-PO-K-L	150423	SIEN-M18B-PO-S-L	
			NPN	N/O contact	150416	SIEN-M18B-NS-K-L	150417	SIEN-M18B-NS-S-L	
				N/C contact	150420	SIEN-M18B-NO-K-L	150421	SIEN-M18B-NO-S-L	
	8.0	Non-flush	PNP	N/O contact	150426	SIEN-M18NB-PS-K-L	150427	SIEN-M18NB-PS-S-L	
				N/C contact	150430	SIEN-M18NB-PO-K-L	150431	SIEN-M18NB-PO-S-L	
			NPN	N/O contact	150424	SIEN-M18NB-NS-K-L	150425	SIEN-M18NB-NS-S-L	
				N/C contact	150428	SIEN-M18NB-NO-K-L	150429	SIEN-M18NB-NO-S-L	
M30									
	10.0	Flush	PNP	N/O contact	150434	SIEN-M30B-PS-K-L	150435	SIEN-M30B-PS-S-L	
				N/C contact	150438	SIEN-M30B-PO-K-L	150439	SIEN-M30B-PO-S-L	
			NPN	N/O contact	150432	SIEN-M30B-NS-K-L	150433	SIEN-M30B-NS-S-L	
				N/C contact	150436	SIEN-M30B-NO-K-L	150437	SIEN-M30B-NO-S-L	
	15.0	Non-flush	PNP	N/O contact	150442	SIEN-M30NB-PS-K-L	150443	SIEN-M30NB-PS-S-L	
				N/C contact	150446	SIEN-M30NB-PO-K-L	150447	SIEN-M30NB-PO-S-L	
			NPN	N/O contact	150440	SIEN-M30NB-NS-K-L	150441	SIEN-M30NB-NS-S-L	
				N/C contact	150444	SIEN-M30NB-NO-K-L	150445	SIEN-M30NB-NO-S-L	

1) S_n Rated operating distance [mm]

Proximity sensors SIEN-...-PA, inductive

Technical data – Standard switching distance, polyamide housing

Function¹⁾

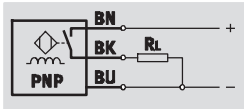

1) e.g. N/O contact with PNP output and cable

- Standard switching distance
- Corrosion-resistant
- Polyamide housing
- For DC voltage
- Round design

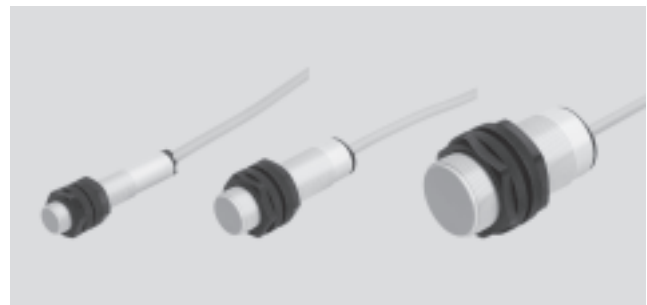

General technical data	
Design	Round
Conforms to	EN 60947-5-2
Certification	cULus listed (OL) RCM trademark
CE mark (see declaration of conformity)	To EU EMC Directive ¹⁾
Note on materials	Free of copper and PTFE

1) For information about the applicability of the component see the manufacturer's EC declaration of conformity at: www.festo.com → Support → User documentation.
If the component is subject to restrictions on usage in residential, office or commercial environments or small businesses, further measures to reduce the emitted interference may be necessary.

Input signal/measuring element		
Ambient temperature	[°C]	-25 ... +70

Output, general							
Mounting type	Flush			Non-flush			
	Size	M12	M18	M30	M12	M18	M30
Repetition accuracy	[mm]	0.04	0.1	0.2	0.08	0.16	0.3

Switching output							
Mounting type	Flush			Non-flush			
	Size	M12	M18	M30	M12	M18	M30
Switching output	PNP			PNP			
	NPN			NPN			
Switching element function	N/O contact			N/O contact			
Rated operating distance	[mm]	2	5	10	4	8	15
Assured switching distance	[mm]	1.62	4.05	8.1	3.24	6.48	12.15
Reduction factors							
Aluminium	0.35 ... 0.5			0.35 ... 0.5			
Stainless steel St 18/8	0.6 ... 1.0			0.6 ... 1.0			
Copper	0.25 ... 0.45			0.25 ... 0.45			
Brass	0.35 ... 0.5			0.35 ... 0.5			
Steel St 37	1.0			1.0			
Hysteresis	[mm]	0.06 ... 0.3	0.15 ... 0.75	0.3 ... 1.5	0.12 ... 0.6	0.24 ... 1.2	0.45 ... 2.25
Max. switching frequency DC	[Hz]	2,000	1,000	500	2,000	1,000	500
Max. output current	[mA]	200			200		
Voltage drop	[V]	≤ 1.8			≤ 1.8		

Output, additional data	
Protection against short circuit	Pulsed

Proximity sensors SIEN-...-PA, inductive

FESTO

Technical data – Standard switching distance, polyamide housing

Electronic components		
Operating voltage range	[V DC]	10 ... 30
Residual ripple	[%]	10
Idle current	[mA]	≤ 15
Reverse polarity protection		For all electrical connections

Electromechanical components	
Electrical connection	Cable, 3-wire
Cable length	[m] 2.5
Cable sheath material	PVC
Insulating sheath material	PVC

Mechanical components						
Size	M12		M18		M30	
Attachment type	Via lock nut					
Mounting type	Flush	Non-flush	Flush	Non-flush	Flush	Non-flush
Tightening torque	[Nm]	–	25	–	25	15
Product weight	[g]	41	38	124	141	48
Housing material	PA-reinforced					

Display/operation	
Switching status display	Yellow LED

Immissions/emissions						
Mounting type	Flush			Non-flush		
Size	M12	M18	M30	M12	M18	M30
Ambient temperature with flexible cable installation	[°C] 0 ... +70			0 ... +70		
Protection class	IP65 IP67			IP67		
Corrosion resistance class CRC ¹⁾	4			4		

1) Corrosion resistance class 4 according to Festo standard 940 070

Components subject to particularly high corrosion stress. Parts used with aggressive media, e.g. in the food or chemical industry. These applications should be supported with special tests with the media if required.

Dimensions

Download CAD data → www.festo.com

M12

1 Connecting cable 2 Active surface

M18

3 LED

Proximity sensors SIEN-...-PA, inductive

Technical data – Standard switching distance, polyamide housing

Dimensions Download CAD data → www.festo.com

M30

1 Connecting cable
2 Active surface
3 LED

Fitting instructions

Flush fitting

2 Active surface
5 Metal-free zone

Non-flush fitting

2 Active surface
5 Metal-free zone

Size	B1	B2	H
M12	18	24	6
M18	27	36	15
M30	45	60	30

Size	B1	B2	H1	H2
M12	18	36	8	12
M18	27	54	16	24
M30	45	90	30	45

Ordering data

Size	S _n ¹⁾ [mm]	Mounting type	Switching output	Switching element function	Electrical connection	
					Part No.	Type
M12						
	2.0	Flush	PNP	N/O contact	538323	SIEN-M12B-PS-K-L-PA
			NPN		538324	SIEN-M12B-NS-K-L-PA
	4.0	Non-flush	PNP		538329	SIEN-M12NB-PS-K-L-PA
			NPN		538330	SIEN-M12NB-NS-K-L-PA
M18						
	5.0	Flush	PNP	N/O contact	538325	SIEN-M18B-PS-K-L-PA
			NPN		538326	SIEN-M18B-NS-K-L-PA
	8.0	Non-flush	PNP		538331	SIEN-M18NB-PS-K-L-PA
			NPN		538332	SIEN-M18NB-NS-K-L-PA
M30						
	10.0	Flush	PNP	N/O contact	538327	SIEN-M30B-PS-K-L-PA
			NPN		538328	SIEN-M30B-NS-K-L-PA
	15.0	Non-flush	PNP		538333	SIEN-M30NB-PS-K-L-PA
			NPN		538334	SIEN-M30NB-NS-K-L-PA

1) S_n Rated operating distance [mm]

Proximity sensors SIED, inductive

Technical data – Standard switching distance, for DC and AC voltage



Function¹⁾

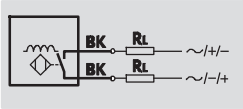

1) e.g. N/O contact with cable

- Standard switching distance
- For DC and AC voltage
- Round design

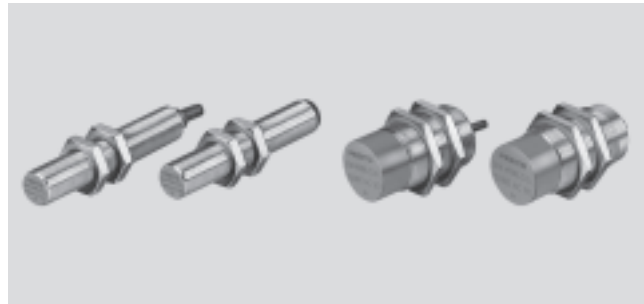

General technical data	
Design	Round
Conforms to	EN 60947-5-2
Certification	cULus listed (OL) RCM trademark
CE mark (see declaration of conformity)	To EU EMC Directive ¹⁾ To EU Low Voltage Directive
Note on materials	Free of copper and PTFE

1) For information about the applicability of the component see the manufacturer's EC declaration of conformity at: www.festo.com → Support → User documentation.
If the component is subject to restrictions on usage in residential, office or commercial environments or small businesses, further measures to reduce the emitted interference may be necessary.

Input signal/measuring element		
Ambient temperature	[°C]	-25 ... +85

Output, general							
Mounting type	Flush			Non-flush			
Size	M12	M18	M30	M12	M18	M30	
Repetition accuracy	[mm]	0.1	0.15	0.3	0.2	0.2	0.4

Switching output							
Mounting type	Flush			Non-flush			
Size	M12	M18	M30	M12	M18	M30	
Switching output	Contactless, 2-wire			Contactless, 2-wire			
Switching element function	N/O contact			N/O contact			
	N/C contact			N/C contact			
Rated operating distance	[mm]	2	5	10	4	8	15
Assured switching distance	[mm]	1.62	4.05	8.1	3.24	6.5	12.5
Reduction factors							
Aluminium	0.5	0.4	0.4	0.6	0.4	0.5	
Stainless steel St 18/8	0.9	0.7	0.7	0.9	0.7	0.8	
Copper	0.4	0.3	0.3	0.5	0.3	0.4	
Brass	0.6	0.4	0.4	0.6	0.4	0.5	
Steel St 37	1.0	1.0	1.0	1.0	1.0	1.0	
Hysteresis	[mm]	0.02 ... 0.44	0.04 ... 1.15	0.05 ... 2.2	0.03 ... 0.88	0.03 ... 1.9	0.04 ... 3.3
Max. switching frequency AC	[Hz]	25			25		
Max. switching frequency DC	[Hz]	1,200	490	200	900	340	220
Max. output current	[mA]	200	300	300	200	300	300
Minimum load current	[mA]	5			5		
Voltage drop	[V]	≤ 8			≤ 8		

Proximity sensors SIED, inductive

Technical data – Standard switching distance, for DC and AC voltage

Output, additional data	
Protection against short circuit	No

Electronic components		
Operating voltage range AC	[V AC]	20 ... 265
Operating voltage range DC	[V DC]	20 ... 320
Idle current	[mA]	≤ 1.5
Reverse polarity protection	For all electrical connections	



Electromechanical components		
Electrical connection	Cable	Plug
Electrical connection	Cable, 2-wire	Plug, M12x1, 2-pin
Cable length	[m]	2.5
Cable sheath material	TPE-U (PUR)	
Insulating sheath material	PVC	

Mechanical components						
Size	M12		M18		M30	
Electrical connection	Cable	Plug	Cable	Plug	Cable	Plug
Attachment type	Via lock nut		Via lock nut		Via lock nut	
Mounting type	Flush		Flush		Flush	
	Non-flush		Non-flush		Non-flush	
Tightening torque	[Nm]	10	20		40	
Product weight	[g]	90	110	50	190	140
Housing materials	Nickel-plated brass, PA		Nickel-plated brass, PA		Nickel-plated brass, PA	

Display/operation	
Switching status display	Yellow LED

Immissions/emissions		
Electrical connection	Cable	Plug
Ambient temperature with flexible cable installation	[°C]	-5 ... +50
Protection class	IP67	IP67
Corrosion resistance class CRC ¹⁾	1	1

1) Corrosion resistance class 1 according to Festo standard 940 070
 Components subject to low corrosion stress. Transport and storage protection. Parts that do not have primarily decorative surface requirements, e.g. in internal areas that are not visible or behind covers.

Pin allocation to EN 60947-5-2				
M12x1, 2-pin				
N/O contact			N/C contact	
	Pin	Wire colour	Allocation	
	3	Black	/+/-	
	4	Black	/-/+	

Proximity sensors SIED, inductive

Technical data – Standard switching distance, for DC and AC voltage

Dimensions – M12

Download CAD data → www.festo.com

Flush fitting

Cable

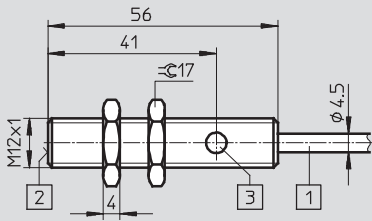

1 Connecting cable 2 Active surface

Plug

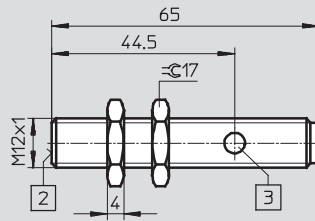

3 LED

Non-flush fitting

Cable

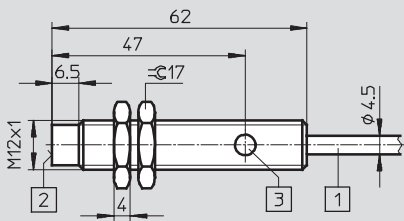

1 Connecting cable 2 Active surface

Plug

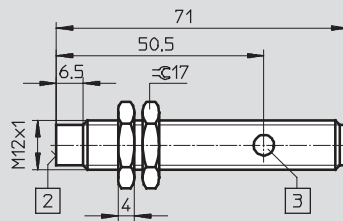

3 LED

Dimensions – M18

Download CAD data → www.festo.com

Flush fitting

Cable

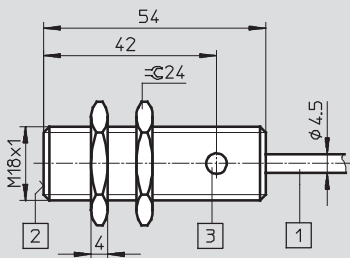

1 Connecting cable 2 Active surface

Plug

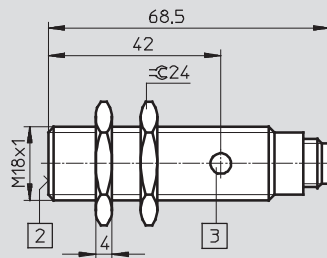

3 LED

Non-flush fitting

Cable

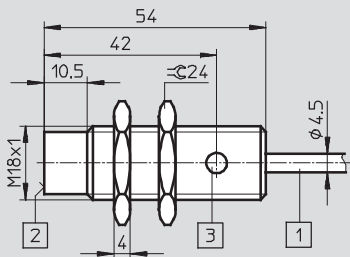

1 Connecting cable 2 Active surface

Plug

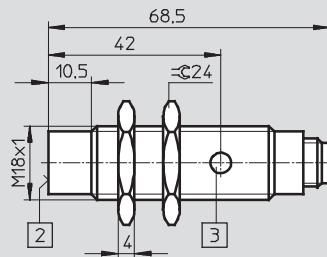

3 LED

Proximity sensors SIED, inductive

Technical data – Standard switching distance, for DC and AC voltage

Dimensions – M30 Download CAD data → www.festo.com

Flush fitting		Non-flush fitting	
Cable	Plug	Cable	Plug
1 Connecting cable	2 Active surface	3 LED	

Fitting instructions

Flush fitting	Non-flush fitting

Size	B1	B2	H
M12	6	12	6
M18	11	30	10
M30	25	37	16

Size	B1	B2	H1	H2
M12	15	27	8	8
M18	20	50	15	15
M30	30	80	15	25



Ordering data

Size	S _n ¹⁾ [mm]	Mounting type	Switching output	Switching element function	Electrical connection			
					Cable		Plug	
					Part No.	Type	Part No.	Type
M12								
	2.0	Flush	Contactless, 2-wire	N/O contact	538272	SIED-M12B-ZS-K-L	538271	SIED-M12B-ZS-S-L
				N/C contact	538274	SIED-M12B-ZO-K-L	538273	SIED-M12B-ZO-S-L
	4.0	Non-flush	Contactless, 2-wire	N/O contact	538268	SIED-M12NB-ZS-K-L	538267	SIED-M12NB-ZS-S-L
				N/C contact	538270	SIED-M12NB-ZO-K-L	538269	SIED-M12NB-ZO-S-L
M18								
	5.0	Flush	Contactless, 2-wire	N/O contact	538280	SIED-M18B-ZS-K-L	538279	SIED-M18B-ZS-S-L
				N/C contact	538282	SIED-M18B-ZO-K-L	538281	SIED-M18B-ZO-S-L
	8.0	Non-flush	Contactless, 2-wire	N/O contact	538276	SIED-M18NB-ZS-K-L	538275	SIED-M18NB-ZS-S-L
				N/C contact	538278	SIED-M18NB-ZO-K-L	538277	SIED-M18NB-ZO-S-L

Proximity sensors SIED, inductive

FESTO

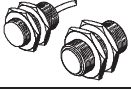
Technical data – Standard switching distance, for DC and AC voltage

Ordering data								
Size	S _n ¹⁾ [mm]	Mounting type	Switching output	Switching element function	Electrical connection			
					Cable		Plug	
					Part No.	Type	Part No.	Type
M30								
	10.0	Flush	2-wire, contactless	N/O contact	538288	SIED-M30B-ZS-K-L	538287	SIED-M30B-ZS-S-L
				N/C contact	538290	SIED-M30B-ZO-K-L	538289	SIED-M30B-ZO-S-L
	15.0	Non-flush	2-wire, contactless	N/O contact	538284	SIED-M30NB-ZS-K-L	538283	SIED-M30NB-ZS-S-L
				N/C contact	538286	SIED-M30NB-ZO-K-L	538285	SIED-M30NB-ZO-S-L

1) S_n Rated operating distance [mm]

Proximity sensors SIED-...-PA, inductive

Technical data – Standard switching distance, polyamide housing, for DC and AC voltage

Function¹⁾

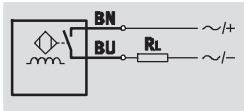

1) e.g. N/O contact with cable

- Standard switching distance
- Corrosion-resistant
- Polyamide housing
- For DC and AC voltage
- Round design

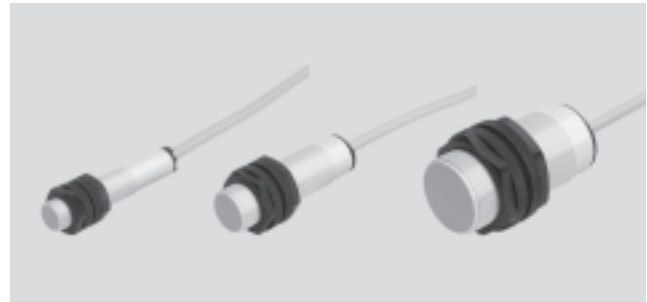

General technical data	
Design	Round
Conforms to	EN 60947-5-2
Certification	cULus listed (OL) RCM trademark
CE mark (see declaration of conformity)	To EU EMC Directive ¹⁾ To EU Low Voltage Directive
Note on materials	Free of copper and PTFE

1) For information about the applicability of the component see the manufacturer's EC declaration of conformity at: www.festo.com → Support → User documentation.
If the component is subject to restrictions on usage in residential, office or commercial environments or small businesses, further measures to reduce the emitted interference may be necessary.

Input signal/measuring element		
Ambient temperature	[°C]	-25 ... +70

Output, general							
Mounting type	Flush			Non-flush			
Size	M12	M18	M30	M12	M18	M30	
Repetition accuracy	[mm]	0.04	0.1	0.2	0.08	0.16	0.3

Switching output							
Mounting type	Flush			Non-flush			
Size	M12	M18	M30	M12	M18	M30	
Switching output	Contactless, 2-wire			Contactless, 2-wire			
Switching element function	N/O contact			N/O contact			
Rated operating distance	[mm]	2	5	10	4	8	15
Assured switching distance	[mm]	1.62	4.05	8.1	3.24	6.48	12.15
Reduction factors							
Aluminium	0.35 ... 0.5			0.35 ... 0.5			
Stainless steel St 18/8	0.06 ... 0.1			0.06 ... 0.1			
Copper	0.25 ... 0.45			0.25 ... 0.45			
Brass	0.35 ... 0.5			0.35 ... 0.5			
Steel St 37	1.0			1.0			
Hysteresis	[mm]	0.06 ... 0.3	0.15 ... 0.75	0.3 ... 1.5	0.12 ... 0.6	0.24 ... 1.2	0.45 ... 2.25
Max. switching frequency AC	[Hz]	20			20		
Max. switching frequency DC	[Hz]	60			60		
Max. output current	[mA]	100	300	300	100	300	300
Minimum load current	[mA]	3			3		
Voltage drop	[V]	≤ 6			≤ 6		

Output, additional data	
Protection against short circuit	No

Proximity sensors SIED-...-PA, inductive

FESTO

Technical data – Standard switching distance, polyamide housing, for DC and AC voltage

Electronic components		
Operating voltage range AC	[V AC]	20 ... 250
Operating voltage range DC	[V DC]	10 ... 300
Idle current	[mA]	≤ 1.5
Reverse polarity protection		For all electrical connections

Electromechanical components	
Electrical connection	Cable, 2-wire
Cable length	[m] 2.5
Cable sheath material	PVC
Insulating sheath material	PVC

Mechanical components			
Size	M12	M18	M30
Attachment type	Via lock nut		
Mounting type	Flush		
Tightening torque	[Nm] 1	2	5
Product weight	[g] 109	123	175
Housing material	PA-reinforced		

Display/operation	
Switching status display	Yellow LED

Immissions/emissions	
Ambient temperature with flexible cable installation	[°C] 0 ... +70
Protection class	IP65, IP67
Corrosion resistance class CRC ¹⁾	4

1) Corrosion resistance class 4 according to Festo standard 940 070
 Components subject to particularly high corrosion stress. Parts used with aggressive media, e.g. in the food or chemical industry. These applications should be supported with special tests with the media if required.

Dimensions

Download CAD data → www.festo.com

M12

1 Connecting cable 2 Active surface 3 LED

M18

1 Connecting cable 2 Active surface 3 LED

Proximity sensors SIED-...-PA, inductive

Technical data – Standard switching distance, polyamide housing, for DC and AC voltage

Dimensions Download CAD data → www.festo.com

M30

- 1 Connecting cable
- 2 Active surface
- 3 LED

Fitting instructions

Flush fitting

- 2 Active surface
- 5 Metal-free zone

Non-flush fitting

- 2 Active surface
- 5 Metal-free zone

Size	B1	B2	H
M12	18	24	6
M18	27	36	15
M30	45	60	30

Size	B1	B2	H1	H2
M12	18	36	8	12
M18	27	54	16	24
M30	45	90	30	45

Ordering data						
Size	S _n ¹⁾ [mm]	Mounting type	Switching output	Switching element function	Electrical connection	
					Cable	Part No. Type
M12						
	2.0	Flush	Contactless, 2-wire	N/O contact	538336	SIED-M12B-ZS-K-L-PA
	4.0	Non-flush			538335	SIED-M12NB-ZS-K-L-PA
M18						
	5.0	Flush	Contactless, 2-wire	N/O contact	538338	SIED-M18B-ZS-K-L-PA
	8.0	Non-flush			538337	SIED-M18NB-ZS-K-L-PA
M30						
	10.0	Flush	Contactless, 2-wire	N/O contact	538340	SIED-M30B-ZS-K-L-PA
	15.0	Non-flush			538339	SIED-M30NB-ZS-K-L-PA

1) S_n Rated operating distance [mm]

Proximity sensors SIES, inductive

Technical data – Standard switching distance, special design



Function¹⁾

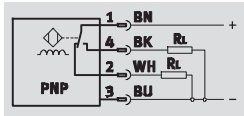

1) e.g. antivalent with PNP output and terminals

- Standard switching distance
- For DC voltage
- Block-shaped design

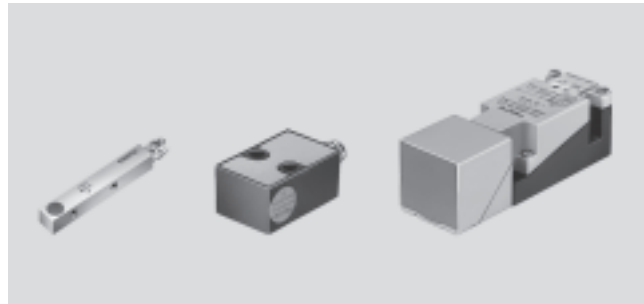

General technical data	
Conforms to	EN 60947-5-2
Certification	cULus listed (OL) RCM trademark
CE mark (see declaration of conformity)	To EU EMC Directive ¹⁾
Note on materials	Free of copper and PTFE

1) For information about the applicability of the component see the manufacturer's EC declaration of conformity at: www.festo.com → Support → User documentation.
If the component is subject to restrictions on usage in residential, office or commercial environments or small businesses, further measures to reduce the emitted interference may be necessary.

Input signal/measuring element						
Type		SIES-Q5	SIES-Q8	SIES-V3	SIES-QB	SIES-Q40
Size	[mm]	5x5x25	8x8x40	15x20x30	12x26x40	40x40x120
Ambient temperature	[°C]	-25 ... +70		-25 ... +85		

Output, general						
Type		SIES-Q5	SIES-Q8	SIES-V3	SIES-QB	SIES-Q40
Size	[mm]	5x5x25	8x8x40	15x20x30	12x26x40	40x40x120
Repetition accuracy	[mm]	0.04	0.075	0.1	0.1	0.75

Switching output						
Type		SIES-Q5	SIES-Q8	SIES-V3	SIES-QB	SIES-Q40
Size	[mm]	5x5x25	8x8x40	15x20x30	12x26x40	40x40x120
Switching output		PNP NPN		PNP NPN		PNP -
Switching element function		N/O contact N/C contact		N/O contact N/C contact		Antivalent
Rated operating distance	[mm]	0.8	1.5	2		15
Assured switching distance	[mm]	0.64	1.2	1.6		12.2
Reduction factors						
Aluminium		0.4		0.45		0.3
Stainless steel St 18/8		0.7	0.8	0.7	0.8	0.7
Copper		0.3	0.2	0.3	0.35	0.25
Brass		0.4	0.5	0.5		0.3
Steel St 37		1.0		1.0		1.0
Max. switching frequency DC	[Hz]	3,000	1,500	1,200		100
Max. output current	[mA]	200		-		-
Max. output current at ≤ 50 °C	[mA]	-		200		200
Max. output current at ≤ 85 °C	[mA]	-		150		150
Voltage drop	[V]	-		≤ 1.8		≤ 1.8

Proximity sensors SIES, inductive

Technical data – Standard switching distance, special design

Output, additional data	
Protection against short circuit	Pulsed

Electronic components						
Type		SIES-Q5	SIES-Q8	SIES-V3	SIES-QB	SIES-Q40
Size	[mm]	5x5x25	8x8x40	15x20x30	12x26x40	40x40x120
Operating voltage range	[V DC]	10 ... 30				
Residual ripple	[%]	10				
Idle current	[mA]	≤ 10		≤ 30		≤ 40
Reverse polarity protection		For all electrical connections				

Electromechanical components							
Electrical connection		Cable			Plug		
Type		SIES-Q5	SIES-Q8	SIES-QB	SIES-Q8	SIES-V3	SIES-Q40
Size	[mm]	5x5x25	8x8x40	12x26x40	8x8x40	15x20x30	40x40x120
Electrical connection		Cable, 3-wire			Plug, M8x1, 3-pin		Screw terminal
Cable length	[m]	2.5			-		-
Cable sheath material		TPE-U (PUR)			-		-

Mechanical components						
Type		SIES-Q5	SIES-Q8	SIES-V3	SIES-QB	SIES-Q40
Size	[mm]	5x5x25	8x8x40	15x20x30	12x26x40	40x40x120
Attachment type		Via female thread		Via through-hole		
Mounting type		Flush		Flush		
Product weight	[g]	22	15	120	170	230
Housing material		Nickel-plated brass		Die-cast zinc	PBT-reinforced	PBT

Display/operation						
Type		SIES-Q5	SIES-Q8	SIES-V3	SIES-QB	SIES-Q40
Size	[mm]	5x5x25	8x8x40	15x20x30	12x26x40	40x40x120
Ready status display		-				Green LED
Switching status display		Yellow LED				Yellow LED

Immissions/emissions						
Type		SIES-Q5	SIES-Q8	SIES-V3	SIES-QB	SIES-Q40
Size	[mm]	5x5x25	8x8x40	15x20x30	12x26x40	40x40x120
Protection class		IP67				IP65

Pin allocation to EN 60947-5-2			
M8x1, 3-pin			
N/O contact and N/C contact			
	Pin	Wire colour	Allocation
	1	Brown	+
	3	Blue	-
	4	Black	Output

Proximity sensors SIES, inductive

Technical data – Standard switching distance, special design



Download CAD data → www.festo.com

SIES-Q5B Cable	SIES-Q8B Cable	Plug
<p>1 Connecting cable 2 Active surface</p>	<p>3 LED 4 4x LED</p>	

Download CAD data → www.festo.com

SIES-V3B Plug	SIES-QB Cable
<p>1 Connecting cable 2 Active surface</p>	<p>3 LED 4 Sensor centre</p>

Download CAD data → www.festo.com

SIES-Q40B Plug	
	<p>2 Supplied with active surface facing forward: sensor head can be adjusted to any one of 5 response directions</p>

Proximity sensors SIES, inductive

Technical data – Standard switching distance, special design

FESTO

Fitting instructions

Flush fitting

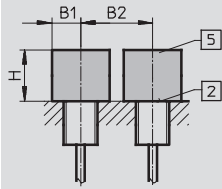

- 2 Active surface
- 5 Metal-free zone

Size	B1	B2	H
5x5x25	2.5	5	2
8x8x40	4	12	3
15x20x30	6	12	5
12x26x40	6	12	5
40x40x120	25	75	30

Ordering data

Size [mm]	S _n ¹⁾ [mm]	Mounting type	Switching output	Switching element function	Electrical connection			
					Cable		Plug	
					Part No.	Type	Part No.	Type
5x5x25								
	0.8	Flush	PNP	N/O contact	178291	SIES-Q5B-PS-K-L	-	
				N/C contact	174549	SIES-Q5B-PO-K-L		
			NPN	N/O contact	178290	SIES-Q5B-NS-K-L		
				N/C contact	174548	SIES-Q5B-NO-K-L		
8x8x40								
	1.5	Flush	PNP	N/O contact	178294	SIES-Q8B-PS-K-L	178295	SIES-Q8B-PS-S-L
				N/C contact	174552	SIES-Q8B-PO-K-L	174553	SIES-Q8B-PO-S-L
			NPN	N/O contact	178292	SIES-Q8B-NS-K-L	178293	SIES-Q8B-NS-S-L
				N/C contact	174550	SIES-Q8B-NO-K-L	174551	SIES-Q8B-NO-S-L
15x20x30								
	2.0	Flush	PNP	N/O contact	-		150491	SIES-V3B-PS-S-L
			NPN				150490	SIES-V3B-NS-S-L
12x26x40								
	2.0	Flush	PNP	N/O contact	150488	SIES-QB-PS-K-L	-	
				N/C contact	150489	SIES-QB-PO-K-L		
40x40x120								
	15.0	Flush	PNP	Antivalent	-		150492	SIES-Q40B-PA-X-2L ²⁾

1) S_n Rated operating distance [mm]

2) Electrical connection via screw terminals

Proximity sensors SIEH, inductive

Technical data – Increased switching distance



Function¹⁾

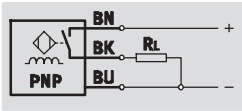

- Increased switching distance
- For DC voltage
- Round design

1) e.g. N/O contact with PNP output and cable

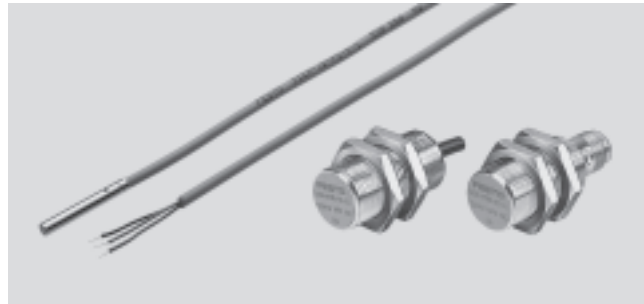

General technical data			
Size	3 mm	M12	M18
Design	Round	–	–
Conforms to	EN 60947-5-2	EN 60947-5-2	EN 60947-5-2
Certification	cULus listed (OL)	cULus listed (OL)	cULus listed (OL)
	RCM trademark	RCM trademark	RCM trademark
CE mark (see declaration of conformity)	To EU EMC Directive ¹⁾	To EU EMC Directive ¹⁾	To EU EMC Directive ¹⁾
Note on materials	Free of copper and PTFE	Free of copper and PTFE	Free of copper and PTFE
	–	–	RoHS-compliant
	–	Contains PWIS (paint-wetting impairment substances)	Contains PWIS (paint-wetting impairment substances)

1) For information about the applicability of the component see the manufacturer's EC declaration of conformity at: www.festo.com → Support → User documentation.
If the component is subject to restrictions on usage in residential, office or commercial environments or small businesses, further measures to reduce the emitted interference may be necessary.

Input signal/measuring element			
Size	3 mm	M12	M18
Ambient temperature	[°C]	–25 ... +70	

Output, general				
Size	3 mm	M12	M18	
Repetition accuracy	[mm]	0.02	–	0.4
Repetition accuracy under constant conditions	[mm]	–	0.2	–

Switching output				
Size	3 mm	M12	M18	
Switching output	PNP	PNP	PNP	
	NPN	NPN	NPN	
Switching element function	N/O contact	N/O contact	N/O contact	
	–	N/C contact	N/C contact	
Rated operating distance	[mm]	1	4	8
Assured switching distance	[mm]	0.81	3.24	6.48
Reduction factors				
Aluminium	0.5	0.4	0.35	
Stainless steel St 18/8	0.8	0.8	0.7	
Copper	0.45	0.4	0.3	
Brass	0.6	0.5	0.4	
Steel St 37	1.0	1.0	1.0	
Hysteresis	[mm]	≤ 0.12	≤ 0.36	≤ 0.88
Switch-on time	[ms]	0.02	–	–
Max. switching frequency	[Hz]	3,000	2,500	1,500
Max. output current	[mA]	100	200	200
Voltage drop	[V]	0 ... 2	–	–

Proximity sensors SIEH, inductive

Technical data – Increased switching distance

Output, additional data			
Size	3 mm	M12	M18
Protection against short circuit	Pulsed	Pulsed	Pulsed
Inductive protective circuit	Integrated	Integrated	–
	Output current < 100 mA		
	and switching frequency < 10 Hz		

Electronic components			
Size	3 mm	M12	M18
Operating voltage range [V DC]	10 ... 30		
Residual ripple [%]	20	±10	±20
Idle current [mA]	0 ... 10		
Reverse polarity protection	For all electrical connections		

Electromechanical components						
Electrical connection	Cable			Plug		
Size	3 mm	M12	M18	3 mm	M12	M18
Electrical connection	Cable, 3-wire			Cable with plug, M8x1, 3-pin	Plug, M12x1, 3-pin	
Cable length [m]	2.5			0.15	–	
Cable sheath material	TPE-U (PUR)			TPE-U (PUR)		
Insulating sheath material	PVC	–	–	PVC	–	

Mechanical components						
Electrical connection	Cable			Plug		
Size	3 mm	M12	M18	3 mm	M12	M18
Attachment type	Clamped	Via lock nut		Clamped	Via lock nut	
Mounting type	Flush			Flush		
Tightening torque [Nm]	–	–	20	–	–	20
Product weight [g]	18	110	108	4	30	43
Housing material	High-alloy stainless steel	Nickel-plated brass		High-alloy stainless steel	Nickel-plated brass	
		PBTP			PBTP	
		–			PA	

Display/operation	
Switching status display	Yellow LED

Immissions/emissions						
Electrical connection	Cable			Plug		
Size	3 mm	M12	M18	3 mm	M12	M18
Ambient temperature with flexible cable installation [°C]	–5 ... +70			–5 ... +70		
Protection class	–	IP65	–	–	IP65	–
	IP67			IP67		
Surge strength [kV]	–	–	0.8	–	–	0.8
Corrosion resistance class CRC ¹⁾	4	2	–	1	2	–
Degree of contamination	–	–	3	–	–	3

1) Corrosion resistance class 1 according to Festo standard 940 070
 Components subject to low corrosion stress. Transport and storage protection. Parts that do not have primarily decorative surface requirements, e.g. in internal areas that are not visible or behind covers.
 Corrosion resistance class 2 according to Festo standard 940 070
 Components subject to moderate corrosion stress. Externally visible parts with primarily decorative surface requirements which are in direct contact with a normal industrial environment or media such as coolants or lubricating agents.
 Corrosion resistance class 4 according to Festo standard 940 070
 Components subject to particularly high corrosion stress. Parts used with aggressive media, e.g. in the food or chemical industry. These applications should be supported with special tests with the media if required.

Proximity sensors SIEH, inductive

Technical data – Increased switching distance



Pin allocation to EN 60947-5-2			
M8x1, 3-pin			
N/O contact			
	Pin	Wire colour	Allocation
	1	Brown	+
	3	Blue	-
	4	Black	Output
M12x1, 3-pin			
N/O contact			
	Pin	Wire colour	Allocation
	1	Brown	+
	3	Blue	-
	4	Black	Output
N/C contact			
	Pin	Wire colour	Allocation
	1	Brown	+
	3	Blue	-
	2	White	Output

Dimensions – 3 mm Download CAD data → www.festo.com

Cable Plug

- 1 Connecting cable
- 2 Active surface
- 3 LED

Dimensions – M12 Download CAD data → www.festo.com

Cable Plug

- 1 Connecting cable
- 2 Active surface
- 3 LED
- 4 4x LED

Dimensions – M18 Download CAD data → www.festo.com

Cable Plug

- 1 Connecting cable
- 2 Active surface
- 3 LED
- 4 4x LED

Fitting instructions



Flush fitting

- 2 Active surface
- 5 Metal-free zone

Size	B1	B2	H
3 mm	2.5	5	3
M12	10	24	12
M18	18	40	24

Proximity sensors SIEH, inductive

Technical data – Increased switching distance

Ordering data								
Size	S _n ¹⁾ [mm]	Mounting type	Switching output	Switching element function	Electrical connection			
					Cable		Plug	
					Part No.	Type	Part No.	Type
3 mm								
	1.0	Flush	PNP	N/O contact	538264	SIEH-3B-PS-K-L	538263	SIEH-3B-PS-S-L
			NPN	N/O contact	538266	SIEH-3B-NS-K-L	538265	SIEH-3B-NS-S-L
M12								
	4.0	Flush	PNP	N/O contact	150450	SIEH-M12B-PS-K-L	150451	SIEH-M12B-PS-S-L
				N/C contact	150454	SIEH-M12B-PO-K-L	150455	SIEH-M12B-PO-S-L
			NPN	N/O contact	150448	SIEH-M12B-NS-K-L	150449	SIEH-M12B-NS-S-L
				N/C contact	150452	SIEH-M12B-NO-K-L	150453	SIEH-M12B-NO-S-L
M18								
	7.0	Flush	PNP	N/O contact	150458	SIEH-M18B-PS-K-L	150459	SIEH-M18B-PS-S-L
				N/C contact	150462	SIEH-M18B-PO-K-L	150463	SIEH-M18B-PO-S-L
			NPN	N/O contact	150456	SIEH-M18B-NS-K-L	150457	SIEH-M18B-NS-S-L
				N/C contact	150460	SIEH-M18B-NO-K-L	150461	SIEH-M18B-NO-S-L

1) S_n Rated operating distance [mm]

Proximity sensors SIEH-...-CR, inductive

Technical data – Increased switching distance



Function¹⁾

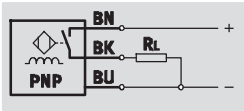

1) e.g. N/O contact with PNP output and cable

- Increased switching distance
- For DC voltage
- Round design
- Resistant to chemicals and mechanical stress



General technical data				
Size	M12		M18	
Switching output	PNP	NPN	PNP	NPN
Conforms to	EN 60947-5-2		EN 60947-5-2	
Certification	cULus listed (OL)	–	cULus listed (OL)	–
	RCM trademark		RCM trademark	
CE mark (see declaration of conformity)	To EU EMC Directive ¹⁾		To EU EMC Directive ¹⁾	
Note on materials	Free of copper and PTFE		Free of copper and PTFE	

1) For information about the applicability of the component see the manufacturer's EC declaration of conformity at: www.festo.com → Support → User documentation.
If the component is subject to restrictions on usage in residential, office or commercial environments or small businesses, further measures to reduce the emitted interference may be necessary.

Input signal/measuring element		
Ambient temperature	[°C]	–25 ... +70

Output, general		
Size	M12	M18
Reproducibility, switching value FS	[mm]	0.3
		0.5

Switching output				
Size	M12		M18	
Switching output	PNP	NPN	PNP	NPN
Switching output	PNP		PNP	
	NPN		NPN	
Switching element function	N/O contact		N/O contact	
Rated operating distance	[mm]	6	10	
Assured switching distance	[mm]	4.86	8.1	
Reduction factors				
Aluminium		1.0	1.0	
Stainless steel, 1 mm thick		0.45	0.4	
Stainless steel, 2 mm thick		0.9	0.8	
Copper		0.85	0.8	0.85
Brass		1.3	1.3	
Steel St 37		1.0	1.0	
Hysteresis	[mm]	≤ 0.73		≤ 1.22
Max. switching frequency	[Hz]	400	600	200
Max. output current	[mA]	200		
Voltage drop	[V]	2	≤ 2	2
				≤ 2

Proximity sensors SIEH-...-CR, inductive

Technical data – Increased switching distance

Output, additional data	
Protection against short circuit	Pulsed
Inductive protective circuit	Integrated
	Output current < 100 mA
	and switching frequency < 10 Hz

Electronic components		
Switching output	PNP	NPN
Operating voltage range [V DC]	10 ... 30	10 ... 30
Residual ripple [%]	20	20
Idle current [mA]	< 12	≤ 17
Reverse polarity protection	For all electrical connections	For all electrical connections

Electromechanical components		
Electrical connection	Cable	Plug
Electrical connection	Cable, 3-wire	Plug, M12x1, 3-pin
Cable sheath material	TPE-U (PUR)	–

Mechanical components				
Size	M12		M18	
Electrical connection	Cable	Plug	Cable	Plug
Size	M12		M18	
Attachment type	Via lock nut		Via lock nut	
Mounting type	Flush		Flush	
Product weight [g]	90	28	115	53
Housing material	High-alloy stainless steel		High-alloy stainless steel	

Display/operation	
Switching status display	Yellow LED

Immissions/emissions				
Size	M12		M18	
Switching output	PNP	NPN	PNP	NPN
Ambient temperature with flexible cable installation [°C]	–5 ... +70		–5 ... +70	
Protection class	IP67		IP67	
	IP69K		IP69K	
Corrosion resistance class CRC ¹⁾	2	4	2	4
Resistance to sensor fitting pressure [bar]	80		60	

1) Corrosion resistance class 2 according to Festo standard 940 070
 Components subject to moderate corrosion stress. Externally visible parts with primarily decorative surface requirements which are in direct contact with a normal industrial environment or media such as coolants or lubricating agents.
 Corrosion resistance class 4 according to Festo standard 940 070
 Components subject to particularly high corrosion stress. Parts used with aggressive media, e.g. in the food or chemical industry. These applications should be supported with special tests with the media if required.

Pin allocation to EN 60947-5-2			
M8x1, 3-pin			
N/O contact			
	Pin	Wire colour	Allocation
	1	Brown	+
	3	Blue	–
	4	Black	Output
M12x1, 3-pin			
N/O contact			
	Pin	Wire colour	Allocation
	1	Brown	+
	3	Blue	–
	4	Black	Output
N/C contact			
	Pin	Wire colour	Allocation
	1	Brown	+
	3	Blue	–
	2	White	Output

Proximity sensors SIEH-...-CR, inductive

Technical data – Increased switching distance



Dimensions – M12 Download CAD data → www.festo.com

Cable Plug

- 1 Connecting cable
- 2 Active surface
- 3 LED

Dimensions – M18 Download CAD data → www.festo.com

Cable Plug

- 1 Connecting cable
- 2 Active surface
- 3 LED

Fitting instructions

Flush fitting

Size	B1	B2	H
M12	12	40	18
M18	25	60	30

- 2 Active surface
- 5 Metal-free zone

Ordering data								
Size	S _n ¹⁾ [mm]	Mounting type	Switching output	Switching element function	Electrical connection			
					Cable		Plug	
					Part No.	Type	Part No.	Type
M12								
	6.0	Flush	PNP	N/O contact	538252	SIEH-M12B-PS-K-L-CR	538251	SIEH-M12B-PS-S-L-CR
			NPN	N/O contact	538254	SIEH-M12B-NS-K-L-CR	538253	SIEH-M12B-NS-S-L-CR
M18								
	10.0	Flush	PNP	N/O contact	538256	SIEH-M18B-PS-K-L-CR	538255	SIEH-M18B-PS-S-L-CR
			NPN	N/O contact	538258	SIEH-M18B-NS-K-L-CR	538257	SIEH-M18B-NS-S-L-CR

1) S_n Rated operating distance [mm]

Proximity sensors SIEA, inductive

Technical data – Analogue output

Function¹⁾

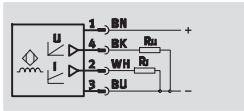

1) e.g. with analogue output for current and voltage

- Analogue output
- For DC voltage
- Round design



General technical data	
Design	Round
Certification	cULus listed (OL) RCM trademark
CE mark (see declaration of conformity)	To EU EMC Directive ¹⁾
Note on materials	Free of copper and PTFE

1) For information about the applicability of the component see the manufacturer's EC declaration of conformity at: www.festo.com → Support → User documentation.
If the component is subject to restrictions on usage in residential, office or commercial environments or small businesses, further measures to reduce the emitted interference may be necessary.

Input signal/measuring element					
Size		M8	M12	M18	M30
Ambient temperature	[°C]	-25 ... +70		-25 ... +70	
Position measuring range	[mm]	0 ... 4	0 ... 6	0 ... 10	0 ... 20
Distance resolution	[mm]	0.001		0.002	0.005
Temperature drift of real switching distance	[%]	≤ ±10 (-25 ... 0 °C)		≤ ±10	
	[%]	≤ ±5 (0 ... 70 °C)			

Output, general					
Size		M8	M12	M18	M30
Repetition accuracy	[mm]	0.3		0.3	
Repetition accuracy under constant conditions	[mm]	±0.01		±0.02	±0.05

Switching output					
Size		M8	M12	M18	M30
Analogue output	[V]	0 ... 10	0 ... 10	0 ... 10	0 ... 10
	[mA]	-	4 ... 20	4 ... 20	4 ... 20
Output voltage at 23 °C	[V]	+10/±0.4 (s = 4 mm)	+10/±0.4 (s = 6 mm)	+10/±0.4 (s = 10 mm)	+10/±0.4 (s = 20 mm)
	[V]	+5.2/±0.4 (s = 2 mm)	+5.2/±0.4 (s = 3 mm)	+5.2/±0.4 (s = 5 mm)	+5.2/±0.4 (s = 10 mm)
	[V]	0/-0 +0.4 (s = 0 mm)	0/-0 +0.4 (s = 0 mm)	0/-0 +0.4 (s = 0 mm)	0/-0 +0.4 (s = 0 mm)
Output current at 23 °C	[mA]	-	20/±0.8 (s = 6 mm)	20/±0.8 (s = 10 mm)	20/±0.8 (s = 20 mm)
	[mA]	-	4/±0.8 (s = 0 mm)	4/±0.8 (s = 0 mm)	4/±0.8 (s = 0 mm)

Reduction factors					
Aluminium		0.28	0.28	0.18	0.2
Stainless steel St 18/8		0.68	0.47	0.6	0.65
Copper		0.25	0.2	0.15	0.17
Brass		0.4	0.35	0.28	0.3
Steel St 37		1.0	1.0	1.0	1.0

Proximity sensors SIEA, inductive

Technical data – Analogue output

Switching output		M8	M12	M18	M30
Size					
Max. switching frequency DC	[Hz]	1,600	1,000	500	200
Bandwidth	[Hz]	1,600 (-3 dB at s = 2 mm)	1,000 (-3 dB at s = 3 mm)	500 (-3 dB at s = 5 mm)	200 (-3 dB at s = 10 mm)
Max. load at analogue current output	[Ω]	–	500	500	500
Max. load current at analogue voltage output	[mA]	10	10	10	10
Max. current/voltage output value without object	[%]	120	120	120	120

Output, additional data	
Protection against short circuit	Pulsed
Protection against overloading	Yes

Electronic components	
Operating voltage range	[V DC] 15 ... 30
Residual ripple	[%] 20
Idle current	[mA] ≤ 10
Reverse polarity protection	For operating voltage

Electromechanical components		M8	M12	M18	M30
Size					
Electrical connection		Plug, M8x1, 3-pin	Plug, M12x1, 4-pin		
Cable length	[m]	2.5			

Mechanical components		M8	M12	M18	M30
Size					
Attachment type		Via lock nut			
Mounting type		Flush			
Tightening torque	[Nm]	4	10	25	70
Product weight	[g]	25	33	55	155
Housing material		Chrome-plated brass			

Immissions/emissions	
Protection class	IP67
Corrosion resistance class CRC ¹⁾	2

1) Corrosion resistance class 2 according to Festo standard 940 070
 Components subject to moderate corrosion stress. Externally visible parts with primarily decorative surface requirements which are in direct contact with a normal industrial environment or media such as coolants or lubricating agents.

Pin allocation			
M8x1, 3-pin		M12x1, 4-pin	
	Pin	Wire colour	Allocation
	1	Brown	+
	3	Blue	-
	4	Black	Voltage
	1	Brown	+
	2	White	Current
	3	Blue	-
	4	Black	Voltage

Proximity sensors SIEA, inductive

Technical data – Analogue output

Dimensions Download CAD data → www.festo.com

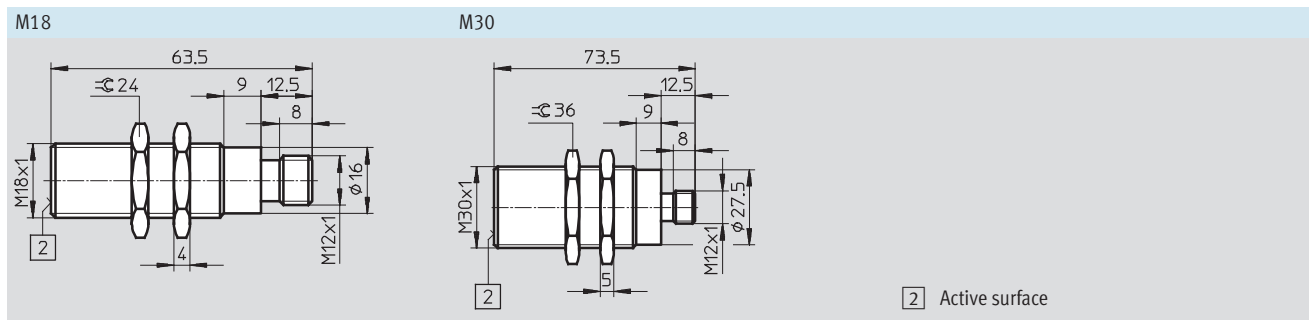
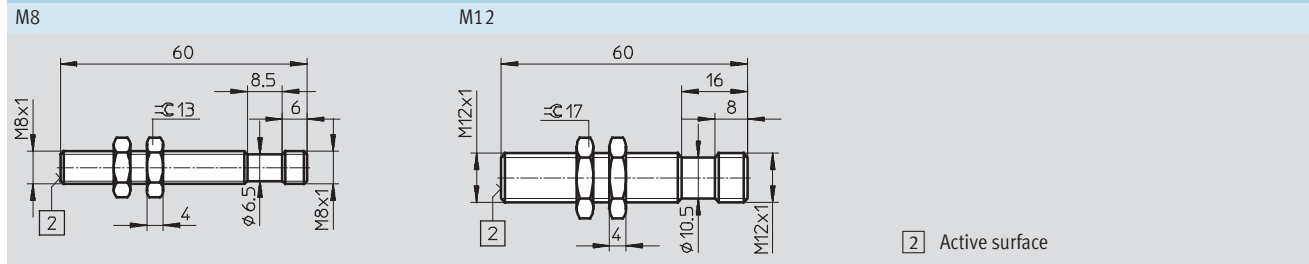

Fitting instructions

Flush fitting

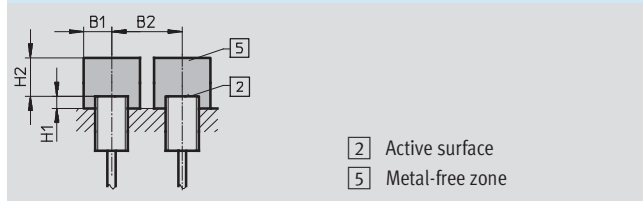

Size	B1	B2	H1	H2
M8	8	20	1	12
M12	12	30	2	18
M18	19	44	4	30
M30	35	80	6	60

Ordering data

Size	S ¹⁾ [mm]	Mounting type	Analogue output		Electrical connection	
					Plug	
					Part No.	Type
M8						
	0 ... 4	Flush	0 ... 10 V	–	538291	SIEA-M8B-PU-S
M12						
	0 ... 6	Flush	0 ... 10 V	4 ... 20 mA	538292	SIEA-M12B-UI-S
M18						
	0 ... 10	Flush	0 ... 10 V	4 ... 20 mA	538293	SIEA-M18B-UI-S
M30						
	0 ... 20	Flush	0 ... 10 V	4 ... 20 mA	538294	SIEA-M30B-UI-S

1) S Position measuring range [mm]

Proximity sensors SIEF, inductive

Technical data – Increased switching distance, reduction factor 1, welding field immune



Function¹⁾

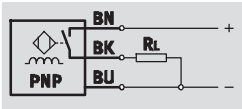

1) e.g. N/O contact with PNP output and cable

- Standard switching distance
- Reduction factor 1 for all metals
- For DC voltage
- Round design

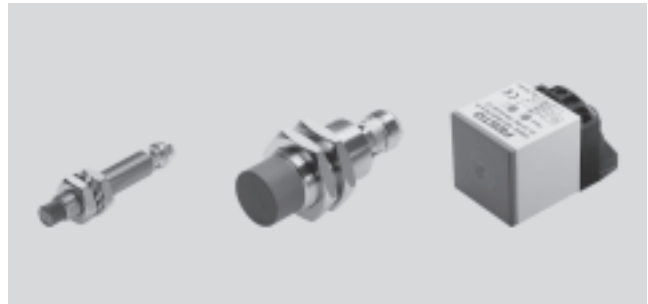

General technical data										
Mounting type	Flush					Partially flush				
Size	M8	M12	M18	M30	M8	M12	M18	M30	Q40	
Design	Round					Round				Block-shaped
Conforms to	EN 60947-5-2					EN 60947-5-2				
Certification	cULus listed (OL)					cULus listed (OL)				
	RCM trademark					RCM trademark				
CE mark (see declaration of conformity)	To EU EMC Directive ¹⁾					To EU EMC Directive ¹⁾				
Note on materials	Free of copper and PTFE					Free of copper and PTFE				
	RoHS-compliant					–				

1) For information about the applicability of the component see the manufacturer's EC declaration of conformity at: www.festo.com → Support → User documentation.
If the component is subject to restrictions on usage in residential, office or commercial environments or small businesses, further measures to reduce the emitted interference may be necessary.

Input signal/measuring element										
Mounting type	Flush					Partially flush				
Electrical connection	Cable			Plug		Cable			Plug	
Ambient temperature [°C]	–30 ... +70			–30 ... +85		–30 ... +85				

Output, general										
Mounting type	Flush					Partially flush				
Size	M8	M12	M18	M30	M8	M12	M18	M30	Q40	
Repetition accuracy [mm]	0.08	0.16	0.28	0.55	0.08	0.16	0.24	0.4	0.7	

Switching output										
Mounting type	Flush					Partially flush				
Size	M8	M12	M18	M30	M8	M12	M18	M30	Q40	
Switching output	PNP					PNP				
	NPN					NPN				
Switching element function	N/O contact					N/O contact				Antivalent
Rated operating distance [mm]	1.5	3	5	10	4	8	12	20	35	
Assured switching distance [mm]	–	–	–	–	3.24	6.48	9.72	16.2	28.35	
Reduction factors										
Aluminium	–					1.0				
Stainless steel St 18/8	–					1.0				
Copper	–					1.0				
Brass	–					1.0				
Steel St 37	–					1.0				
Hysteresis [mm]	–					0.12...0.6	0.24...1.2	0.36...1.8	0.36...1.8	1.05...5.25
Max. switching frequency DC [Hz]	2,000	3,000	2,500	2,000	2,000	2,000	2,000	1,500	250	
Max. output current [mA]	150	200				150	200			
Voltage drop [V]	–					≤ 1.8				

Proximity sensors SIEF, inductive

Technical data – Increased switching distance, reduction factor 1, welding field immune

Output, additional data	
Protection against short circuit	Pulsed

Electronic components										
Mounting type	Flush				Partially flush					
Size	M8	M12	M18	M30	M8	M12	M18	M30	Q40	
Operating voltage range [V DC]	10 ... 30				10 ... 30					10 ... 65
Residual ripple [%]	–				10					10
Idle current [mA]	–				≤ 15					≤ 15
Reverse polarity protection	For all electrical connections				For all electrical connections					

Electromechanical components										
Mounting type	Flush				Partially flush					
Size	M8	M12	M18	M30	M8	M12	M18	M30	Q40	
Cable										
Electrical connection	Cable, 3-wire				Cable, 3-wire					–
Cable length [m]	2.5				2.5					
Cable sheath material	TPE-U (PUR)				TPE-U (PUR)					
Insulating sheath material	PVC				PVC					
Plug										
Electrical connection	Plug, M8x1, 3-pin	Plug, M12x1, 3-pin			Plug, M8x1, 3-pin	Plug, M12x1, 3-pin, Fixcon			Plug, M12x1, 4-pin, Fixcon	
Plug housing material	Chrome-plated brass				Chrome-plated brass					

Mechanical components									
Mounting type	Flush								
Size	M8		M12		M18		M30		Q40
Electrical connection	Cable	Plug	Cable	Plug	Cable	Plug	Cable	Plug	Plug
Product weight [g]	61.4	12	105	24	124	41	191	100	156
Housing material	High-alloy stainless steel		Chrome-plated brass		Chrome-plated brass		Chrome-plated brass		PBT-reinforced
	PA		LCP-reinforced		LCP-reinforced		LCP-reinforced		PA
	PP	–	TPE-O	–	TPE-O	–	TPE-O	–	–

Mechanical components									
Mounting type	Partially flush								
Size	M8		M12		M18		M30		Q40
Electrical connection	Cable	Plug	Cable	Plug	Cable	Plug	Cable	Plug	Plug
Attachment type	Via lock nut								Via through-hole
Tightening torque [Nm]	10	10	10	10	25	25	75	75	–
Product weight [g]	77	19	120	22	141	38	194	90	156
Housing material	High-alloy stainless steel		Chrome-plated brass		Chrome-plated brass		Chrome-plated brass		PBT-reinforced
	PA		PBT		PBT		PBT		PA

Proximity sensors SIEF, inductive

Technical data – Increased switching distance, reduction factor 1, welding field immune

Display/operation										
Mounting type	Flush				Partially flush					
Size	M8	M12	M18	M30	M8	M12	M18	M30	Q40S	
Ready status display	–				–					Green LED
Switching status display	Yellow LED				Yellow LED					Yellow LED

Immissions/emissions										
Electrical connection	Cable				Plug					
Size	M8	M12	M18	M30	M8	M12	M18	M30	Q40	
Flush										
Ambient temperature with flexible cable installation [°C]	–5 ... +70				–					–
Protection class	IP68				IP68					
Resistance to interference from magnetic fields	Magnetic direct and alternating field				Magnetic direct and alternating field					
Surge resistance [kV]	0.8				0.8					
Corrosion resistance class CRC ¹⁾	2				2					
Degree of contamination	3				3					
Partially flush										
Ambient temperature with flexible cable installation [°C]	0 ... 80				–					–
Protection class	IP67				IP67					
Resistance to interference from magnetic fields	Magnetic direct and alternating field				Magnetic direct and alternating field					
Surge resistance [kV]	–				–					
Corrosion resistance class CRC ¹⁾	4	2			4	2			–	
Degree of contamination	–				–					

1) Corrosion resistance class 2 according to Festo standard 940 070
 Components subject to moderate corrosion stress. Externally visible parts with primarily decorative surface requirements which are in direct contact with a normal industrial environment or media such as coolants or lubricating agents.
 Corrosion resistance class 4 according to Festo standard 940 070
 Components subject to particularly high corrosion stress. Parts used with aggressive media, e.g. in the food or chemical industry. These applications should be supported with special tests with the media if required.

Pin allocation to EN 60947-5-2				Pin allocation to EN 60947-5-2			
M8x1, 3-pin				M12x1, 3-pin			
N/O contact				N/O contact			
	Pin	Wire colour	Allocation		Pin	Wire colour	Allocation
	1	Brown	+		1	Brown	+
	3	Blue	–		3	Blue	–
	4	Black	Output		4	Black	Output

Pin allocation to EN 60947-5-2				Pin allocation to EN 60947-5-2			
M12x1, 4-pin				M12x1, 4-pin			
NPN, antivalent				PNP, antivalent			
	Pin	Wire colour	Allocation		Pin	Wire colour	Allocation
	1	Brown	+		1	Brown	+
	2	White	N/O contact		2	White	N/C contact
	3	Blue	–		3	Blue	–
	4	Black	N/C contact		4	Black	N/O contact

Proximity sensors SIEF, inductive

Technical data – Increased switching distance, reduction factor 1, welding field immune

Dimensions Download CAD data → www.festo.com

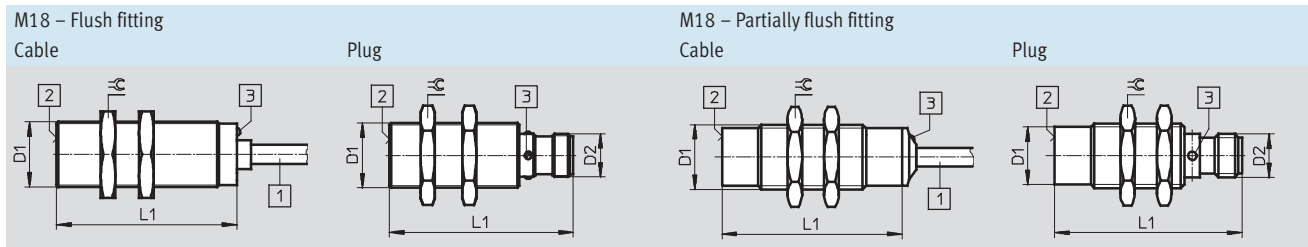
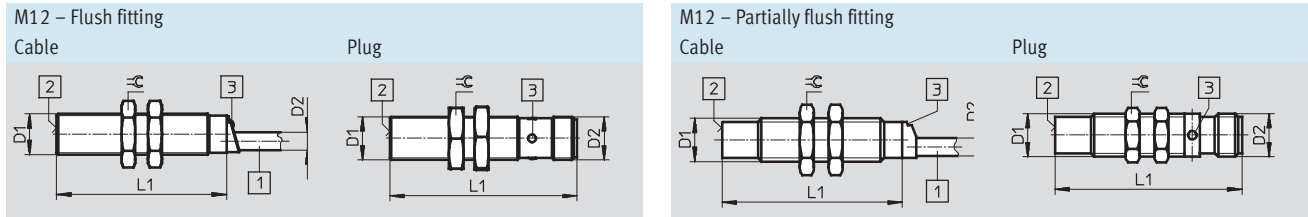
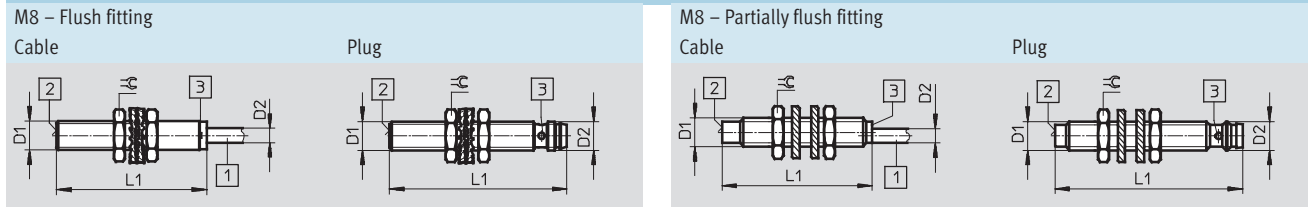

Mounting type	Electrical connection	D1	D2	L1	⌀
M8					
Flush	Cable	M8x1	4	41.6	13
	Plug		M8x1	49	
Partially flush	Cable	M8x1	4	41.6	13
	Plug		M8x1	52	
M12					
Flush	Cable	M12x1	5.2	50	17
	Plug		M12x1	52	
Partially flush	Cable	M12x1	5	50	17
	Plug		M12x1	52	
M18					
Flush	Cable	M18x1	5.2	50	24
	Plug		M12x1	52	
Partially flush	Cable	M18x1	5.2	50	24
	Plug		M12x1	52	

- 1 Connecting cable
- 2 Active surface
- 3 LED

Proximity sensors SIEF, inductive

Technical data – Increased switching distance, reduction factor 1, welding field immune



Dimensions Download CAD data → www.festo.com

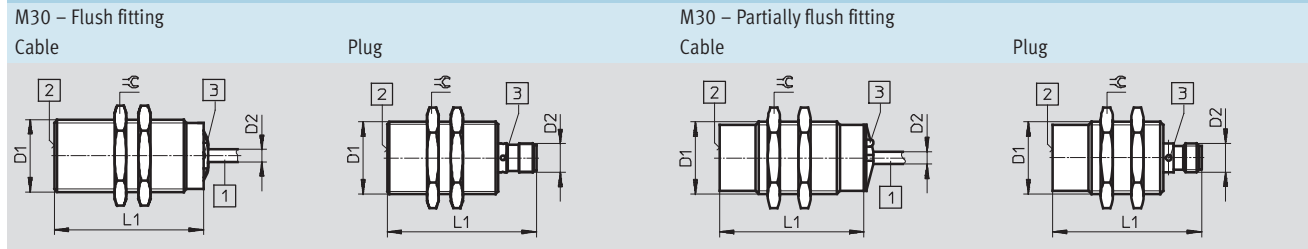

Mounting type	Electrical connection	D1	D2	L1	⌀
M30					
Flush	Cable	M30x1.5	5.2	60	36
	Plug		M12x1	62	
Partially flush	Cable	M30x1.5	5.2	60	36
	Plug		M12x1	62	

- 1 Connecting cable
- 2 Active surface
- 3 LED

Dimensions – 40x40x65 mm Download CAD data → www.festo.com

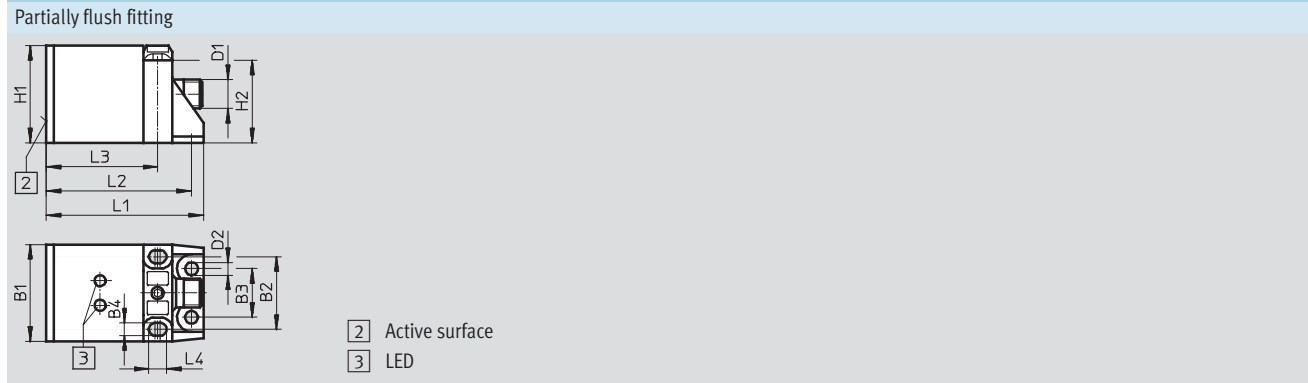

Mounting type	Electrical connection	B1	B2	B3	B4	D1	D2	H1	H2	L1	L2	L3	L4
40x40x65 mm													
Partially flush	Plug	40	30	20	5.3	M12x1	5.3	40	34	65	60	46	7.3

Fitting instructions

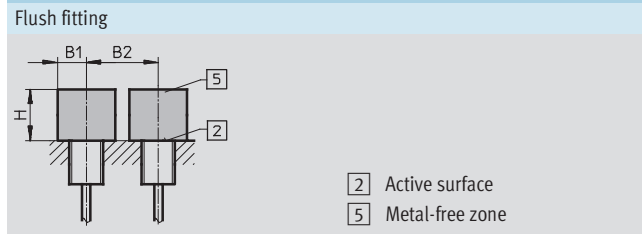

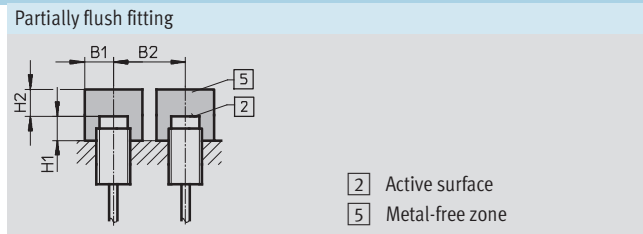

Size	B1	B2	H
M8	12	16	4.5
M12	18	24	12
M18	27	36	15
M30	45	60	30



Size	B1	B2	H1	H2
M8	12	32	8	12
M12	18	48	16	24
M18	27	54	24	36
M30	45	90	30	60
40x40x65 mm	60	120	30	105

Proximity sensors SIEF, inductive

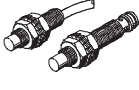
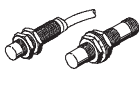
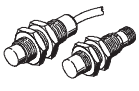
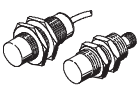
Technical data – Increased switching distance, reduction factor 1, welding field immune

Ordering data								
Size	S _n ¹⁾ [mm]	Mounting type	Switching element function	Switching output	Electrical connection			
					Cable		Plug	
					Part No.	Type	Part No.	Type
M8								
	1.5	Flush	N/O contact	PNP	553538	SIEF-M8B-PS-K-L	553537	SIEF-M8B-PS-S-L
				NPN	553540	SIEF-M8B-NS-K-L	553539	SIEF-M8B-NS-S-L
	4.0	Partially flush		PNP	538308	SIEF-M8NB-PS-K-L	538307	SIEF-M8NB-PS-S-L
				NPN	538310	SIEF-M8NB-NS-K-L	538309	SIEF-M8NB-NS-S-L
M12								
	3.0	Flush	N/O contact	PNP	553542	SIEF-M12B-PS-K-L	553541	SIEF-M12B-PS-S-L
				NPN	553544	SIEF-M12B-NS-K-L	553543	SIEF-M12B-NS-S-L
	8.0	Partially flush		PNP	538312	SIEF-M12NB-PS-K-L	538311	SIEF-M12NB-PS-S-L
				NPN	538314	SIEF-M12NB-NS-K-L	538313	SIEF-M12NB-NS-S-L
M18								
	5.0	Flush	N/O contact	PNP	553546	SIEF-M18B-PS-K-L	553545	SIEF-M18B-PS-S-L
				NPN	553548	SIEF-M18B-NS-K-L	553547	SIEF-M18B-NS-S-L
	12.0	Partially flush		PNP	538316	SIEF-M18NB-PS-K-L	538315	SIEF-M18NB-PS-S-L
				NPN	538318	SIEF-M18NB-NS-K-L	538317	SIEF-M18NB-NS-S-L
M30								
	10.0	Flush	N/O contact	PNP	553550	SIEF-M30B-PS-K-L	553549	SIEF-M30B-PS-S-L
				NPN	553552	SIEF-M30B-NS-K-L	553551	SIEF-M30B-NS-S-L
	20.0	Partially flush		PNP	538320	SIEF-M30NB-PS-K-L	538319	SIEF-M30NB-PS-S-L
				NPN	538322	SIEF-M30NB-NS-K-L	538321	SIEF-M30NB-NS-S-L
40x40x65 mm								
	35.0	Partially flush	Antivalent	PNP	-		538341	SIEF-Q40S-PA-S-2L
				NPN			538342	SIEF-Q40S-NA-S-2L

1) S_n Rated operating distance [mm]

Proximity sensors SIEF-...-WA, inductive

Technical data – Increased switching distance, reduction factor 1, welding field immune



Function¹⁾

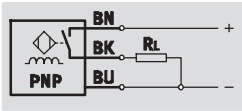

1) e.g. N/O contact with PNP output and cable

- Standard switching distance
- Reduction factor 1 for all metals
- Welding field immune
- For DC voltage
- Round design



General technical data	
Design	Round
Conforms to	EN 60947-5-2
Certification	cULus listed (OL) RCM trademark
CE mark (see declaration of conformity)	To EU EMC Directive ¹⁾

1) For information about the applicability of the component see the manufacturer's EC declaration of conformity at: www.festo.com → Support → User documentation.
If the component is subject to restrictions on usage in residential, office or commercial environments or small businesses, further measures to reduce the emitted interference may be necessary.

Input signal/measuring element		
Ambient temperature	[°C]	-30 ... +85

Output, general							
Mounting type	Flush			Partially flush			
Size	M12	M18	M30	M12	M18	M30	
Repetition accuracy	[mm]	0.06	0.1	0.2	0.16	0.24	0.4

Switching output							
Mounting type	Flush			Partially flush			
Size	M12	M18	M30	M12	M18	M30	
Switching output	PNP NPN						
Switching element function	N/O contact						
Rated operating distance	[mm]	3	5	10	8	12	20
Assured switching distance	[mm]	2.43	4.05	16.2	6.48	9.72	16.2
Reduction factors							
Aluminium	1.0						
Stainless steel St 18/8	1.0						
Copper	1.0						
Brass	1.0						
Steel St 37	1.0						
Hysteresis	[mm]	0.24 ... 1.2	0.15 ... 0.75	0.36 ... 1.8	0.24 ... 1.2	0.36 ... 1.8	0.36 ... 1.8
Max. switching frequency DC	[Hz]	3,000	2,500	1,500	2,000	2,000	1,500
Max. output current	[mA]	200					
Voltage drop	[V]	≤ 1.8					

Output, additional data	
Protection against short circuit	Pulsed

Proximity sensors SIEF-...-WA, inductive

Technical data – Increased switching distance, reduction factor 1, welding field immune

Electronic components		
Operating voltage range	[V DC]	10 ... 30
Residual ripple	[%]	10
Idle current	[mA]	≤ 15
Reverse polarity protection		For all electrical connections

Electromechanical components	
Electrical connection	Plug, M12x1, 3-pin, Fixcon
Plug housing material	PTFE-coated brass

Mechanical components								
Size	M12		M18		M30			
Mounting type	Flush	Partially flush	Flush	Partially flush	Flush		Partially flush	
Switching output	PNP/NPN	PNP/NPN	PNP/NPN	PNP/NPN	PNP	NPN	PNP	NPN
Attachment type	Via lock nut							
Tightening torque	[Nm]	7		15		75		75
Product weight	[g]	26		48		373		464, 919, 1,010
Housing material	PTFE-coated brass							
	PBT							

Display/operation	
Switching status display	Yellow LED

Immissions/emissions	
Protection class	IP67
Resistance to interference from magnetic fields	Magnetic direct and alternating field

Pin allocation to EN 60947-5-2			
M12x1, 3-pin			
N/O contact			
	Pin	Wire colour	Allocation
	1	Brown	+
	3	Blue	-
	4	Black	Output

Proximity sensors SIEF-...-WA, inductive



Technical data – Increased switching distance, reduction factor 1, welding field immune

Dimensions Download CAD data → www.festo.com

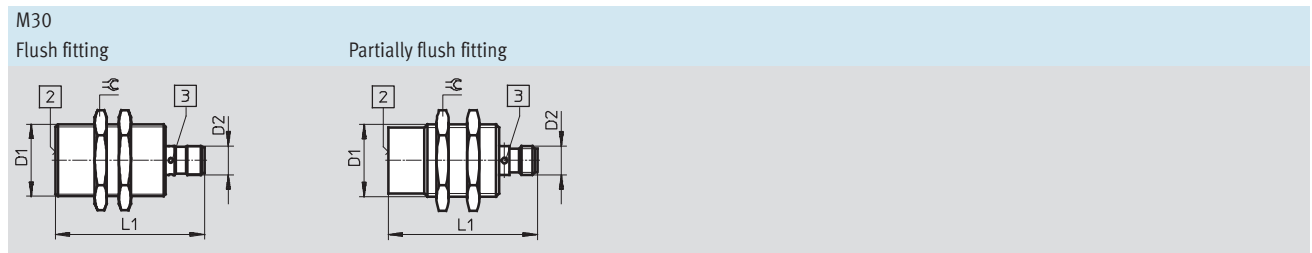
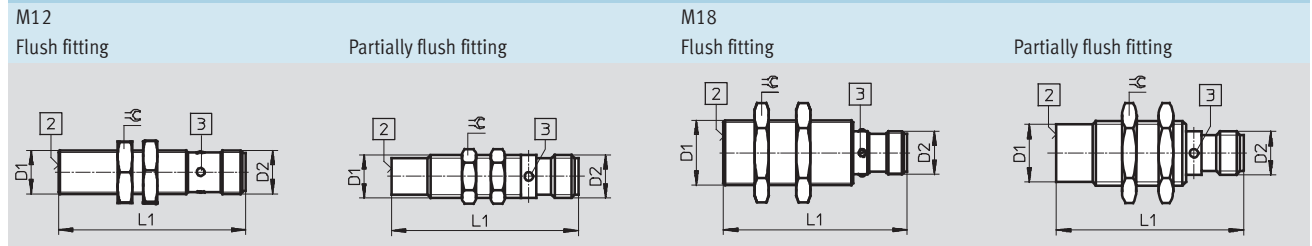

Mounting type	Electrical connection	D1	D2	L1	☞
M12					
Flush	Plug	M12x1	M12x1	52	17
Partially flush					13
M18					
Flush	Plug	M18x1	M12x1	52	24
Partially flush					
M30					
Flush	Plug	M30x1.5	M12x1	62	36
Partially flush					

- 2 Active surface
- 3 LED

Fitting instructions

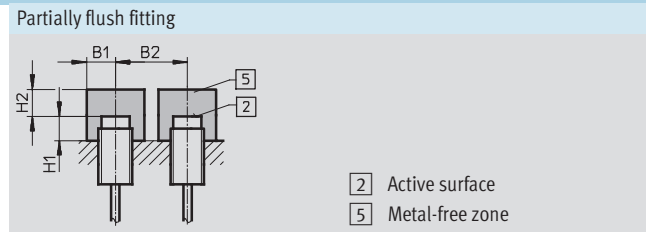
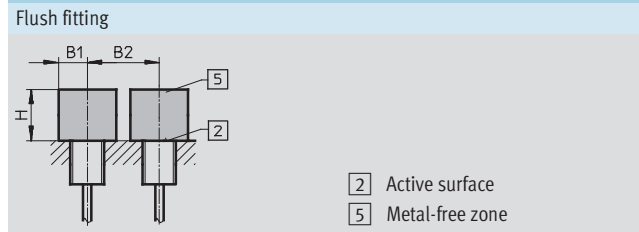



Size	B1	B2	H
M12	18	24	9
M18	27	36	15
M30	45	60	30

Size	B1	B2	H1	H2
M12	18	48	16	24
M18	27	54	24	36
M30	45	90	40	60

Proximity sensors SIEF-...-WA, inductive

Technical data – Increased switching distance, reduction factor 1, welding field immune



Ordering data						
Size	S _n ¹⁾ [mm]	Mounting type	Switching element function	Switching output	Electrical connection	
					Plug	
					Part No.	Type
M12						
	3.0	Flush	N/O contact	PNP	538297	SIEF-M12B-PS-S-L-WA
				NPN	538298	SIEF-M12B-NS-S-L-WA
	8.0	Partially flush		PNP	538295	SIEF-M12NB-PS-S-L-WA
				NPN	538296	SIEF-M12NB-NS-S-L-WA
M18						
	5.0	Flush	N/O contact	PNP	538301	SIEF-M18B-PS-S-L-WA
				NPN	538302	SIEF-M18B-NS-S-L-WA
	12.0	Partially flush		PNP	538299	SIEF-M18NB-PS-S-L-WA
				NPN	538300	SIEF-M18NB-NS-S-L-WA
M30						
	10.0	Flush	N/O contact	PNP	538305	SIEF-M30B-PS-S-L-WA
				NPN	538306	SIEF-M30B-NS-S-L-WA
	20.0	Partially flush		PNP	538303	SIEF-M30NB-PS-S-L-WA
				NPN	538304	SIEF-M30NB-NS-S-L-WA

1) S_n Rated operating distance [mm]



Proximity sensors SIE..., inductive

Accessories

FESTO







Ordering data – Connecting cables M8x1				
				Technical data → Internet: nebu
	Number of wires	Cable length [m]	Part No.	Type
Straight socket				
	3	2.5	541333	NEBU-M8G3-K-2.5-LE3
		5	541334	NEBU-M8G3-K-5-LE3
Angled socket				
	3	2.5	541338	NEBU-M8W3-K-2.5-LE3
		5	541341	NEBU-M8W3-K-5-LE3
Straight socket, straight plug				
	4	2.5	554037	NEBU-M8G3-K-2.5-M8G4 ¹⁾





1) For connecting proximity sensor SIEA-M8B to signal converter SVE4-US.

Ordering data – Connecting cables M12x1				
				Technical data → Internet: nebu
	Number of wires	Cable length [m]	Part No.	Type
Straight socket				
	3	2.5	541363	NEBU-M12G5-K-2.5-LE3
		5	541364	NEBU-M12G5-K-5-LE3
	4	2.5	550326	NEBU-M12G5-K-2.5-LE4 ¹⁾
		5	541328	NEBU-M12G5-K-5-LE4 ¹⁾
Angled socket				
	3	2.5	541367	NEBU-M12W5-K-2.5-LE3
		5	541370	NEBU-M12W5-K-5-LE3
	4	2.5	550325	NEBU-M12W5-K-2.5-LE4 ¹⁾
		5	541329	NEBU-M12W5-K-5-LE4 ¹⁾
Straight socket, straight plug				
	4	2.5	554036	NEBU-M12G5-K-2.5-M8G4 ²⁾

1) For connecting proximity sensor SIE...-M12/M18/M30 in N/C contact version with plug.

2) For connecting proximity sensor SIEA-MxxB to signal converter SVE4.

Ordering data – Mounting attachments			
	For size	Part No.	Type
Sensor bracket with stop for flush fitting			
	M8	538346	SIEZ-B-8
	M12	538348	SIEZ-B-12
	M18	538350	SIEZ-B-18
	M30	538352	SIEZ-B-30
Sensor bracket without stop			
	4	538343	SIEZ-NB-4
	6.5	538344	SIEZ-NB-6,5
	M8	538345	SIEZ-NB-8
	M12	538347	SIEZ-NB-12
	M18	538349	SIEZ-NB-18
	M30	538351	SIEZ-NB-30
	M12, M18	538354	SIEZ-UH
	M12, M18	538355	SIEZ-UV
Inscription label			
	M12 ... M30	538353	SIEZ-LB

Ordering data – Mounting attachments			
	For size	Part No.	Type
Foot mounting			
	M12	5123	HBN-8/10x1
Flange mounting			
	M30	195855	FBN-32
Mounting bracket			
	SIES-V3B	9634	HV-M5
Stop			
	M8	11542	SDA-8x1-B
	M12	11541	SDA-12x1-B